

nbn™ Enterprise Ethernet Operations Manual

Wholesale Broadband Agreement



nbn™ Enterprise Ethernet Operations Manual

Wholesale Broadband Agreement

Version	Description	Effective Date
4.0	First issued version of WBA4 for the nbn™ Enterprise Ethernet Operations Module	1 December 2020
4.1	Applying Enterprise Ethernet Delivery Rebates, Amendments to support Test and Diagnostic Tests, create and update Trouble Tickets and view Planned and Unplanned Outage information via B2B Access.	16 November 2021
4.x	Amendments to support enhanced service delivery and delivery of nbn™ Enterprise Ethernet Products into data centres	30 June 2022

Copyright

This document is subject to copyright and must not be used except as permitted below or under the Copyright Act 1968 (Cth). You must not reproduce or publish this document in whole or in part for commercial gain without the prior written consent of nbn. You may reproduce and publish this document in whole or in part for educational or non-commercial purposes as approved by nbn in writing.

Copyright © 2021~~2~~ nbn co Limited. All rights reserved. Not for general distribution.

Disclaimer

This document is provided for information purposes only. The recipient must not use this document other than with the consent of nbn and must make its own inquiries as to the currency, accuracy and completeness of this document and the information contained in it. The contents of this document should not be relied upon as representing nbn's final position on the subject matter of this document, except where stated otherwise. Any requirements of nbn or views expressed by nbn in this document may change as a consequence of nbn finalising formal technical specifications, or legislative and regulatory developments.

Environment

nbn asks that you consider the environment before printing this document.

Table of Contents

Module 1:	Introduction	6
1.1	What is the nbn ™ Enterprise Ethernet Operations Manual?	7
1.1.1	A Living Document	7
1.1.2	nbn ™ Operations User Guide and nbn Enterprise Ethernet Operations User Guide	7
1.1.3	Modules	7
1.1.4	Role Descriptions	8
1.2	Interaction Diagrams	8
1.3	Terminology	9
1.3.1	Interpretation	9
1.3.2	Content	9
1.4	Contacts and the Contact Matrix	10
1.4.1	Maintaining the Contact Matrix	10
1.4.2	Communication Channels	10
Module 2:	On-boarding	11
2.1	In This Module	12
2.1.1	The On-boarding Roadmap	12
2.1.2	Workshops and Training	13
2.2	Conduct Initial On-boarding	13
2.2.1	Define Solution	13
2.2.2	Attend Operational Workshop	13
2.2.3	Conduct Operational Accreditation Testing (OAT)	15
2.3	Authority to Order Products	16
2.4	Conduct Supplemental On-boarding Activities	16
2.4.1	Communicate Changes to Offerings	16
2.4.2	Conduct On-boarding for Future Functionality	16
Module 3:	Physical Access	18
3.1	Physical Access	19
Module 4:	Delivery	20
4.1	In This Module	21
4.2	Pre Order Requirements	21
4.2.1	Request Service Feasibility Assessment	21
4.2.2	Address Enquiry	21
4.3	Confirm Order	21
4.3.1	Confirm order: activities	21
4.3.2	Price Confirmation	23
4.4	Non-Standard Installation and Delivery Prerequisites	23

4.5	Build Activities	23
4.6	Manage Delivery Completions	24
4.7	Products	24
4.7.1	Product Components: Ordering Sequence	24
4.8	Orders	26
4.8.1	About Orders	26
4.8.2	Modifications	31
4.8.3	Disconnect Orders	33
4.8.4	Same POI Migration Orders	35
4.8.5	Local/State POI Migration Order	37
Module 5:	Assurance	41
5.1	In This Module	42
5.2	Log Trouble Ticket	42
5.3	RSP-Reported Fault Rectification	42
5.3.1	Test & Diagnostics	43
5.3.2	Trouble Tickets	45
5.3.3	External Faults	48
5.3.4	Trouble Ticket Queries	49
5.3.5	Updating a Trouble Ticket	49
5.3.6	Technical Bridge	49
5.3.7	Resolving and Closing a Trouble Ticket	50
5.3.8	Escalating an Unresolved Trouble Ticket	51
5.3.9	Enterprise Ethernet Faults related to a Network Fault	51
5.3.10	Customer Impact Statement for Enterprise Ethernet Faults	51
5.4	End User Availability Time	52
5.4.1	Introduction	52
5.4.2	Trouble Ticket Life-cycle	52
5.4.3	Amending End User Availability Time	53
5.4.4	Trouble Ticket site visit – nbn cannot access the site	53
5.5	Network Fault Rectification	53
5.5.1	Infrastructure Restoration Trouble Tickets	53
5.5.2	nbn Reports a Fault to Your Organisation	54
5.6	Planned Outages and Emergency Outages	54
5.6.1	Planned Outage	54
5.6.2	Planned Outage Queries	56
5.6.3	Emergency Outages	56
5.6.4	Embargo Periods	56

Module 6:	Event Management	58
6.1	Event Management	59
Module 7:	Billing and Payments	60
7.1	Billing and Payments	61
7.2	Invoicing	61
7.2.1	Billing Event File (BEF)	61
7.3	Claims Process for Rebates and Credits	62
7.3.1	Credits and Rebates	62
Module 8:	Operational Governance	64
8.1	Operational Governance	65

Module 1: Introduction

1.1 What is the **nbn**TM Enterprise Ethernet Operations Manual?

This document is the **nbn**TM Enterprise Ethernet Operations Manual document which forms part of the Wholesale Broadband Agreement between **nbn** and your organisation.

It describes the specific processes and procedures that apply to the operational aspects of the supply of the **nbn**TM Enterprise Ethernet Product by **nbn** to your organisation under the WBA.

This document does not cover any processes and procedures that apply to activities covered under any Build Agreement but may reference them for context.

Access to facilities for all WBA products is covered under the **WBA Operations Manual**, and this document may reference those processes and procedures for context.

1.1.1 A Living Document

nbn will continue to develop and refine its operational processes. As these changes occur, **nbn** will make corresponding additions and refinements to this document. This will result in changes to the format and content of this document over time.

nbn intends to engage actively with your organisation and Other RSPs in developing these processes.

Note: Module F of the [Head Terms](#) sets out how this document may be changed.

1.1.2 **nbn**TM Operations User Guide and **nbn** Enterprise Ethernet Operations User Guide

The **nbn**TM **Operations User Guide** and **nbn**TM **Enterprise Ethernet Operations User Guide** are companion documents to the WBA, which include a supplement that provides step-by-step work instructions and guidelines for activities that relate to the interactions described in this document.

 **Important:** The **nbn**TM **Operations User Guide** and the **nbn**TM **Enterprise Ethernet Operations User Guide** do not form part of this document or the WBA.

Your organisation can obtain a copy of the latest release of the **nbn**TM **Operations User Guide** and the **nbn**TM **Enterprise Ethernet Operations User Guide** from **nbn**'s Website or by contacting the **nbn** Relationship Point of Contact.

1.1.3 Modules

The table below summarises the modules and which document contains the content supporting the **nbn**TM Enterprise Ethernet Product. Content contained in the **WBA Operations Manual** may apply as varied by, and for the purposes of, this document.

Document	Module	Content
nbn TM Enterprise Ethernet Operations Manual	2. On-boarding	Describes the processes and activities that provide accreditation required to order the nbn TM Enterprise Ethernet Product.
WBA Operations Manual	3. Physical Access	Describes the interactions and activities in connection with the supply of the Facilities Access Service.

Document	Module	Content
nbn TM Enterprise Ethernet Operations Manual	4. Delivery	Describes the interactions and activities that apply to the ordering and provisioning of the nbn TM Enterprise Ethernet Product. All processes and interactions in relation to the ordering and provisioning of an NNI are contained in Module 4 of the WBA Operations Manual .
nbn TM Enterprise Ethernet Operations Manual	5. Assurance	Describes the processes and interactions that apply to the management and resolution of Enterprise Ethernet Faults and other service-related issues. All assurance related processes and interactions in relation to an NNI are contained in Module 5 of the WBA Operations Manual .
WBA Operations Manual	7. Event Management	Describes the processes and interactions that apply if there is a risk of a network impact or if nbn is the Affected Party in a Force Majeure Event.
WBA Operations Manual	8. Billing and Payments	Describes the billing processes and requirements that apply in connection with Products, as modified and supplemented by Module 7 of this document.
WBA Operations Manual	9. Operational Governance	Describes the types of reporting that nbn will make available to your organisation and the governance processes that will apply in relation to nbn 's operational performance.

1.1.4 Role Descriptions

Role	Description
RSP Support Centre	RSP Support Centre provides the 'front-of-house' function at nbn . The methods of communication with this team are via the nbn TM Enterprise Ethernet Portal, telephone and email. RSP Support Centre is responsible for the following: <ul style="list-style-type: none"> • Responding to Enterprise Ethernet Fault / Trouble Ticket enquiries • Providing overall operational support in relation to nbnTM Enterprise Ethernet.
Network Planning & Deployment (NPD)	NPD is responsible for the fulfilment of your organisation's orders.
Workforce Management	Workforce Management determines and coordinates nbn 's workforce capacity to address Delivery (refer to Module 4: Delivery) and Assurance (refer to Module 5: Assurance) issues.

1.2 Interaction Diagrams

The key purpose of this document is to describe the operational interactions that can occur between your organisation and **nbn**.

To help illustrate these interactions, this document uses interaction diagrams, based on the Business Process Model & Notation (BPMN) v2.0 'Choreography' model.

Note: Interaction diagrams are a refinement of the information contained in process diagrams, focussing on the messages (interactions) that **nbn** and your organisation exchange.

Interaction diagrams provide an at-a-glance summary of the interactions relating to a particular operational aspect. They also indicate the general sequence in which these interactions are likely to occur, and if relevant,

the circumstances that may trigger the interaction. However, they do not indicate the amount of time that elapses between the interactions.



Important: Interaction diagrams are for illustrative purposes and for assistance only. They do not govern **nbn**'s and your organisation's rights and obligations and are not contractually binding on either **nbn** or your organisation.

The following diagram breaks down the elements of an interaction diagram, as used in this document:

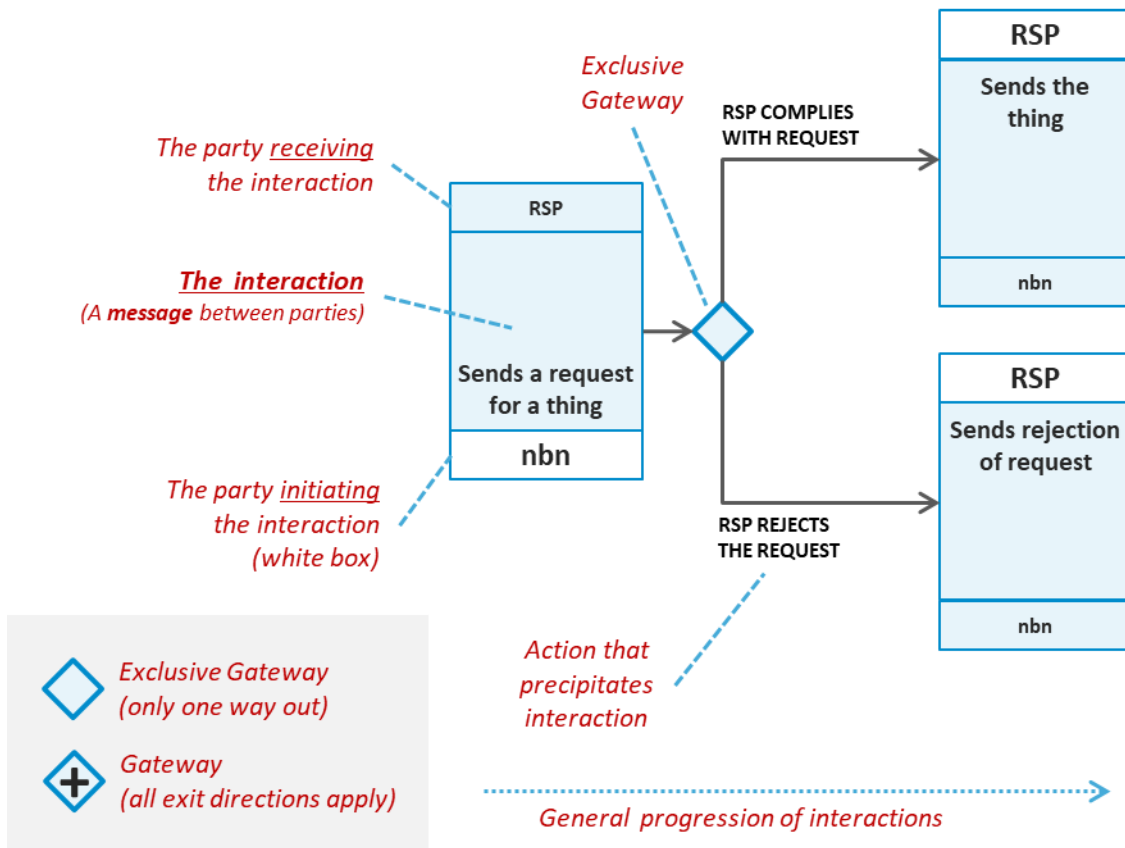

1.3 Terminology

1.3.1 Interpretation

Capitalised terms have the meanings given to those terms in the [Dictionary](#) of the WBA.

1.3.2 Content

The content in this document relates only to the supply of products and services by **nbn** by means of the Enterprise Ethernet Network.

1.4 Contacts and the Contact Matrix

When complete, the **Contact Matrix** sets out the contact details for the Personnel from both **nbn** and your organisation who can be contacted in relation to the interactions described in the WBA. The **Contact Matrix** will be created during On-boarding - see section 2.2.2 of the **WBA Operations Manual**. Your organisation may obtain a copy of the **Contact Matrix** by contacting the **nbn** Relationship Point of Contact.

1.4.1 Maintaining the Contact Matrix

Both **nbn** and your organisation must ensure that the **Contact Matrix** contains up-to-date details of its Personnel in accordance with clause H1.3 of the [Head Terms](#), and (with the exception of changes to your organisation's Authorised Contacts which are dealt with in section 8.8.1.1. of the **WBA Operations Manual**), must advise each other in writing of any changes to those Personnel or their contact details within 2 Business Days of the change.

1.4.2 Communication Channels

Any communication from a party to the other party in relation to this document may be given through any of the following channels:

- Email
- Letter
- The **nbn**™ Enterprise Ethernet Portal



Important: B2B Access cannot be used for this purpose, except for the limited communications specifically set out in the B2B Specifications.

- Any other form of communication as may be notified by **nbn** to your organisation from time to time. Different notification requirements apply to any contentious matter or dispute: see clause H1.1(e) and H1.1(f) of the [Head Terms](#).

Each communication in relation to this document must be given to the other party's relevant contact as specified in the **Contact Matrix**, or as otherwise provided in this document.



Important: Where a section of this document or clause H1.1 of the [Head Terms](#) requires a communication to be given in a specific manner, then this section [1.4.2 Communication Channels](#) does not apply and the communication must be given in the manner specified within that section.

Module 2: On-boarding

2.1 In This Module

This module describes the processes and activities that your organisation must undertake to obtain accreditation prior to ordering the **nbn**™ Enterprise Ethernet Product.



Important: Successful **nbn**™ Ethernet On-boarding is a pre-requisite to On-boarding for **nbn**™ Enterprise Ethernet.

These are the On-boarding processes and activities referred to in clause C1 of the [Head Terms](#).

Your organisation must complete all of the On-boarding processes and activities set out in section [2.2 Conduct Initial On-boarding](#) prior to ordering any Product, Product Component or Product Feature.

Your organisation may be required to conduct supplemental On-boarding, for example, when there are significant changes in the Enterprise Ethernet Network, Product, Product Components and/or Product Features: see section [2.4 Conduct Supplemental On-boarding Activities](#).

The On-boarding processes and activities described in this module will assist to operationally prepare your organisation for interacting with **nbn** in relation to the supply, installation and configuration of Products.

The consultation between **nbn** and your organisation during On-boarding is intended to provide your organisation with a greater understanding of **nbn**'s operational processes.

On-boarding is also intended to assist your organisation to ensure that its systems and proposed RSP Products or technologies are aligned, and compatible with, **nbn**'s systems and Products.

nbn will reasonably assist your organisation in the performance and completion of the On-boarding processes and activities.

Your organisation must complete all of the On-boarding processes and activities at its own cost.

2.1.1 The On-boarding Roadmap

On-boarding consists of a number of stages; each stage is comprised of a sequence of activities.

The following diagram illustrates the stages and activities involved; sections [2.2](#) to [2.4](#) describe each of these in detail:

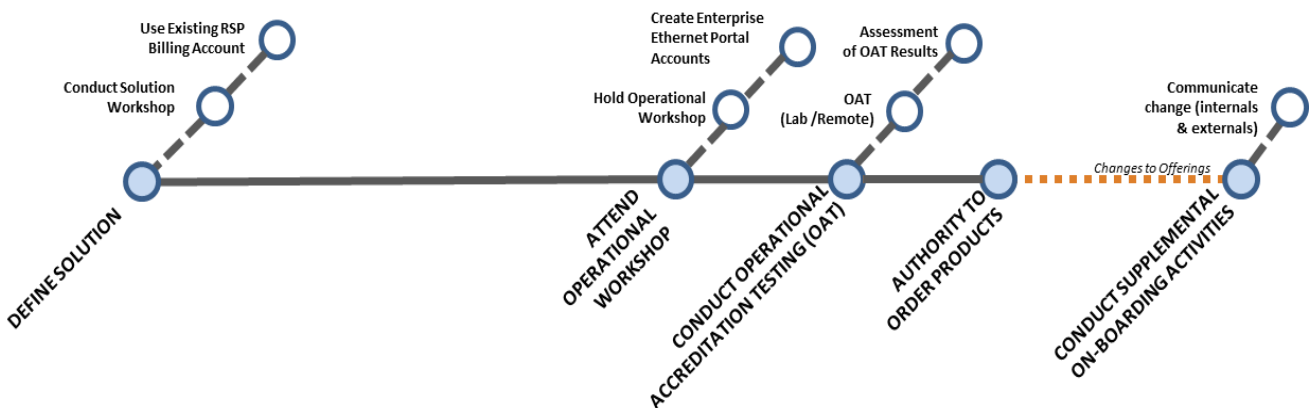

Your organisation must do all of the following (unless otherwise agreed with **nbn**):

- Attend the Solution Workshop
- Attend the Operational Workshop prior to conducting Operational Accreditation Testing
- Conduct Operational Accreditation Testing prior to being authorised to order Products.

The Operational Workshop must be held after the Solution Workshop, but may be held on the same day.

2.1.2 Workshops and Training

During the On-boarding process, **nbn** may provide workshops and training sessions for your organisation.

The purpose of the workshops and training sessions is to educate your organisation's Personnel (for example, contact centre and service desk staff) who will be involved in day-to-day transactions between **nbn** and your organisation.



Important: Prior to each workshop or training session, **nbn** will notify your organisation of the type of Personnel (being people who understand your organisation's business, technical integration, operations and provisioning requirements) that must attend the workshop or training session. Your organisation must ensure that a reasonable number of these Personnel attend the workshop or training session.

2.2 Conduct Initial On-boarding

2.2.1 Define Solution

2.2.1.1 Conduct Solution Workshop

nbn will hold a workshop designed to explain each of the following (Solution Workshop):

- Products
- Interfaces and related integration requirements
- Requirements for the Sandpit
- Other aspects of the On-boarding process, such as the Operational Workshop and Operational Accreditation Testing (OAT)
- How the construction, technology and hardware architecture associated with your organisation's RSP Network, RSP Platform, RSP Products, systems and services generally need to successfully interact with the Enterprise Ethernet Network, **nbn**TM Platform and Products.

2.2.2 Attend Operational Workshop

2.2.2.1 Hold Operational Workshop

nbn will hold a workshop, designed to introduce your organisation to working with **nbn** (Operational Workshop). It may include each of the following topics:

- Overview of **nbn**TM documentation (including this document, the **Contact Matrix** and the **EE Test & Diagnostic Checklist**)
- Roles and responsibilities for both **nbn** and your organisation
- Delivery
- Assurance
- **nbn**TM Enterprise Ethernet Portal
- Billing.

In the journey leading up to the workshop, your organisation will be introduced to a range of documents/resources. The following table describes the documents commonly referred to elsewhere in this document:

Document	Description
<i>nbn™ Enterprise Ethernet Operations Manual</i>	This document which describes the interactions between your organisation and nbn in relation to nbn™ Enterprise Ethernet
<i>WBA Operations Manual</i>	The <i>WBA Operations Manual</i> which describes the interactions between your organisation and nbn in relation to other Products
<i>Contact Matrix</i>	<p>When complete, the <i>Contact Matrix</i> sets out contact details for Personnel from both nbn and your organisation, who can be contacted in relation to the interactions described in the WBA.</p> <div style="background-color: #fff9c4; padding: 10px; border: 1px solid #ccc;"> <p> Important: nbn may request certain elements of the <i>Contact Matrix</i> information prior to the Operational Workshop to complete the set up process for Operational Accreditation Testing. Within 10 Business Days of completing the Operational Workshop, your organisation must do both of the following:</p> <ul style="list-style-type: none"> • Complete the full details of your Personnel who can be contacted in relation to the matters specified in the <i>Contact Matrix</i> • Provide the completed Contact Matrix to nbn </div> <p>Both nbn and your organisation must ensure that the <i>Contact Matrix</i> contains up-to-date details of their respective Personnel in accordance with clause H1.3 of the Head Terms.</p> <p>Whenever those Personnel or their contact details change, each party must advise the other party of those changes in accordance with section 1.4.1 Maintaining the Contact Matrix.</p>
<i>EE Test & Diagnostic Checklist</i>	The <i>EE Test & Diagnostic Checklist</i> will assist your organisation to identify Enterprise Ethernet Faults prior to reporting them to nbn .

Note: **nbn** will organise the Operational Workshop for a date and time suitable to both your organisation and **nbn**. It may be held either on the same day as the Solution Workshop, or at a later date.

2.2.2.2 Create **nbn™ Enterprise Ethernet Portal User Accounts**

As part of On-boarding user accounts need to be created to access the **nbn™ Enterprise Ethernet Portal**.

Your organisation will be required to submit a form in order to create these new user accounts, indicating whether each of the accounts should be configured and registered with either Business or Business Plus account permissions.

Refer to the ***Enterprise Ethernet Operations User Guide*** for further information.

2.2.3 Conduct Operational Accreditation Testing (OAT)



Important: Your organisation must have completed the Operational Workshop and any of its prerequisites before OAT can begin

This testing stage consists of the following activities:

Activity	Purpose
Perform OAT	Evaluates whether your organisation can effectively interact with the Enterprise Ethernet Network and systems.
Assessment of OAT Results	Determines whether or not your organisation’s technology and systems can interoperate effectively with the Enterprise Ethernet Network and systems

2.2.3.1 Perform OAT

Preparation for OAT

In preparation for OAT, **nbn** will do each of the following in respect of each Product Testing Module:

- Provide your organisation with an OAT Plan
- Confirm with your organisation, the mutually-agreed period during which the test environment will be made available to perform elements of the testing.

Testing Locations and Access Times

OAT will be conducted remotely (at a mutually-agreed time), between **nbn’s** and your organisation’s respective facilities, using the OAT environment for the **nbn™** Enterprise Ethernet Portal.

Constraints

For each relevant Product Testing Module, your organisation must perform and complete OAT:

- Via telephone or email (the performance of which **nbn** must be reasonably able to monitor)
- During the mutually-agreed period for the relevant Product Testing Module’s OAT Plan.

nbn Participation

nbn or its agents may also choose to participate in the performance of any element of OAT.



Important: Any **nbn** participation in OAT does not alter your organisation’s obligation to both perform and complete testing

Interruptions to Testing

If an incident arises during OAT, which **nbn** determines is critical, the **nbn™** Personnel coordinating the OAT will, as soon as reasonably practicable, inform your organisation’s Personnel performing OAT.



Important: All critical issues must be fixed before your organisation can successfully complete OAT. **nbn** may request your organisation to repeat certain OAT test cases in order to rectify any issues encountered during OAT.

Your organisation must fix any non-critical issues during OAT where reasonably practicable.

2.2.3.2 Assessment of OAT Results

On completion of OAT, **nbn** will do all of the following:

- Determine whether or not your organisation has successfully completed the testing requirements
- Issue an OAT test summary report
- Record any outstanding non-critical issues, and track these issues during the Governance Meetings.

2.3 Authority to Order Products

Upon successful completion of mandatory On-boarding activities for **nbn**TM Enterprise Ethernet, **nbn** will confirm your authority to order **nbn**TM Enterprise Ethernet.

2.4 Conduct Supplemental On-boarding Activities

Following initial On-boarding, your organisation may wish to order **nbn**TM Enterprise Ethernet Product Components or Product Features for which Operational Accreditation Testing has not been performed.

Before your organisation can place such orders, **nbn** may require your organisation to undergo supplemental On-boarding activities for each such Product Component, or Product Feature, as relevant.

2.4.1 Communicate Changes to Offerings

If there are significant changes in the Enterprise Ethernet Network, the **nbn**TM Enterprise Ethernet Product or its Product Components and/or Product Features, **nbn** may require your organisation to take part in supplemental On-boarding activities.

What kinds of changes are considered significant?

Examples include the following (not a comprehensive list):

- **nbn** introduces product variations and enhancements
- **nbn** introduces new systems and/or new processes
- **nbn** updates its systems or processes, including by means of any Minor B2B Interface Change or Major B2B Interface Change

nbn will consider the impact of all changes and costs on your organisation and Other RSPs, and notify your organisation if any supplemental On-boarding activities are necessary.

If **nbn** requires your organisation to complete supplemental On-boarding activities, it will endeavour to bundle multiple changes within a single release (if such changes occur at the same time) to minimise the administrative impact on your organisation. Your organisation must complete any required supplemental On-boarding activities which **nbn** notifies your organisation of, before your organisation is able to place orders for the relevant **nbn**TM Enterprise Ethernet Product Component or Product Feature.

2.4.2 Conduct On-boarding for Future Functionality

nbn may allow your organisation to conduct On-boarding for a proposed product, product component or product feature (each a Future Functionality) prior to the date that the Future Functionality is available to be ordered, in which case:

- **nbn** will invite your organisation to conduct On-boarding for the Future Functionality
- **nbn** will notify your organisation of the terms and conditions which will apply to **nbn's** supply of the Future Functionality for the purposes of On-boarding (Future Functionality On-boarding Terms)
- Your organisation must comply with the Future Functionality On-boarding Terms

- Subject to the Future Functionality On-boarding Terms, this Module 2 will apply to the On-boarding as if references to a Product, Product Component and Product Feature are references to Future Functionality.

Module 3: Physical Access

3.1 Physical Access

This **nbn**[™] Enterprise Ethernet Operations Manual does not apply in respect of physical access to Type 1 Facilities and Type 2 Facilities. If your organisation requires physical access to a Type 1 Facility or Type 2 Facility, your organisation must order the Facilities Access Service under the [WBA](#) and, if applicable, facilities access from an Underlying Facility Provider. Please refer to Module 3 of the **WBA Operations Manual**.

Module 4: Delivery

4.1 In This Module

This module describes the processes and interactions that apply to the ordering and provisioning of **nbn**TM Enterprise Ethernet. It does not create or vary the rights or obligations of any party in respect of Build Activities undertaken by **nbn** under a Build Agreement.

4.2 Pre Order Requirements

4.2.1 Request Service Feasibility Assessment

nbn will provide, from both the **nbn**TM Enterprise Ethernet Portal and B2B Access, tools designed to enable your organisation to determine whether a particular premises is Serviceable at a given point in time.

Who	Activity
Your organisation...	Submits information to perform a Service Feasibility Assessment as either: <ul style="list-style-type: none"> a single premises in the nbnTM Enterprise Ethernet Portal or via B2B Access; or as part of a file containing details of multiple premises in the nbnTM Enterprise Ethernet Portal only
nbn...	Performs the Service Feasibility Assessment for the premises. Note: If the premises is not yet Serviceable in respect of nbn TM Enterprise Ethernet and your organisation requests that nbn make the premises Serviceable, then your organisation must have entered into a Build Agreement with nbn to proceed.
nbn...	Provides an Enterprise Ethernet Quote ID if nbn TM Enterprise Ethernet is available. Note: If Build Activities are required as a precursor to the supply of nbn TM Enterprise Ethernet to the premises, nbn will undertake those Build Activities and any further Service Feasibility Assessment processes under a Build Agreement with your organisation.
Your organisation...	Can progress with order placement.

4.2.2 Address Enquiry

If your organisation wishes to request a Service Feasibility Assessment, but cannot locate a premises to do so, your organisation may raise a Service Request via the **nbn**TM Service Portal and in accordance with section 4.3.1.1 of the **WBA Operations Manual**.

4.3 Confirm Order

4.3.1 Confirm order: activities

If your organisation is using the **nbn**TM Enterprise Ethernet Portal, then:

Who	Activity
Your organisation...	May request an Enterprise Ethernet Quote for a premises where nbn TM Enterprise Ethernet is available.
Your organisation...	Begins the order process by submitting all required information into the nbn TM Enterprise Ethernet Portal.
nbn...	Provides your organisation with pricing information to review.
Your organisation...	Submits an order for nbn TM Enterprise Ethernet in the nbn TM Enterprise Ethernet Portal.

Who	Activity
nbn...	Will review the order details, and will either send your organisation a Rejected Notification or an Order Accepted Notification
nbn...	<i>(If the order is Rejected)</i> will reject the order and notify your organisation that a new order is required.
nbn...	<i>(If the order is accepted)</i> <ul style="list-style-type: none"> will advise your organisation of the Committed Delivery Date; and (if Build Activities are required as a precursor to Delivery) will commence Build Activities under and in accordance with the Build Agreement.
nbn...	Will, where an order: <ul style="list-style-type: none"> <u>has a Committed Delivery Date that is more than 15 Business Days from the date nbn sent your organisation an Order Accepted Notification; and</u> <u>is In Progress</u> on the date which is 15 Business Days prior to the Committed Delivery Date: <ul style="list-style-type: none"> (if nbn considers that Delivery is likely to occur on a date other than the Committed Delivery Date) advise your organisation of a Revised Delivery Date (if nbn considers that Delivery is likely to occur on the Committed Delivery Date) advise your organisation that nbn considers it likely that Delivery will occur on the Committed Delivery Date.
nbn...	<u>Will, in addition to the notification obligation above, advise your organisation as soon as reasonably practicable of a Revised Delivery Date (or further Revised Delivery Date, if applicable), if nbn considers that Delivery is likely to occur on a date other than:</u> <ul style="list-style-type: none"> <u>the Committed Delivery Date; or</u> <u>a previously advised Revised Delivery Date.</u>

If your organisation is using B2B Access, then:

Who	Activity
Your organisation...	May request an Enterprise Ethernet Quote for a premises where nbn TM Enterprise Ethernet is available.
nbn...	Where your organisation has requested an Enterprise Ethernet Quote, provides your organisation an Enterprise Ethernet Quote
Your organisation...	Submits an order for nbn TM Enterprise Ethernet via B2B Access.
nbn...	Will review the order details, and will either send your organisation a Rejected Notification or an Order Accepted Notification
nbn...	<i>(If the order is Rejected)</i> will reject the order and notify your organisation that a new order is required.
nbn...	<i>(If the order is accepted)</i> <ul style="list-style-type: none"> will advise your organisation of the Committed Delivery Date; and (if Build Activities are required as a precursor to Delivery) will commence Build Activities under and in accordance with the Build Agreement.
nbn...	Will, where an order: <ul style="list-style-type: none"> <u>has a Committed Delivery Date that is more than 15 Business Days from the date nbn sent your organisation an Order Accepted Notification: and</u> <u>is In Progress</u> on the date which is prior to the Committed Delivery Date: <ul style="list-style-type: none"> (if nbn considers that Delivery is likely to occur on a date other than the Committed Delivery Date) advise your organisation of a Revised Delivery Date

Who	Activity
	<ul style="list-style-type: none"> (if nbn considers that Delivery is likely to occur on the Committed Delivery Date) advise your organisation that nbn considers it likely that Delivery will occur on the Committed Delivery Date.
nbn...	<p><u>Will, in addition to the notification obligation above, advise your organisation as soon as reasonably practicable of a Revised Delivery Date (or further Revised Delivery Date, if applicable), if nbn considers that Delivery is likely to occur on a date other than:</u></p> <ul style="list-style-type: none"> <u>the Committed Delivery Date; or</u> <u>a previously advised Revised Delivery Date.</u>

Note: Your organisation has 60 Business Days to place an order after receiving the Enterprise Ethernet Quote ID. Where your organisation has not placed an order within 60 Business Days of receiving the Enterprise Ethernet Quote ID, your organisation must request a new Service Feasibility Assessment if it wishes to place an order or request an Enterprise Ethernet Quote.

4.3.2 Price Confirmation

Each Price Confirmation will be in a form determined by **nbn** and may specify:

- The effective charges that will apply to the Ordered Products contained in the order, which will be in accordance with the charges set out in the [nbn™ Enterprise Ethernet Price List](#), less any applicable Discounts, Credits, Rebates or Waivers.
- Whether the Ordered Products contained in the order are subject to an Early Termination Payment in accordance with section 1.1 of the [nbn™ Enterprise Ethernet Price List](#).
- Any other details relevant to the order.

For the purpose of section 1 of the [nbn™ Enterprise Ethernet Product Terms](#), Price Confirmations provided for **nbn™** Enterprise Ethernet Ordered Products with an Order Acknowledgement after the EE Price Transition Date do not vary the Charges or Early Termination Payments in the [nbn™ Enterprise Ethernet Price List](#) or the Discounts, Credits, Rebates and Waivers in any *Discounts, Credits and Rebates Annexure*, which prevail over a Price Confirmation to the extent of any inconsistency.

4.4 Non-Standard Installation and Delivery Prerequisites

See the [nbn™ Enterprise Ethernet Price List](#) for details of the Charges which may apply to Standard Installations.

If **nbn** considers that the order will require a Non-Standard Installation or any Delivery Prerequisites, then following order placement:

Who	Activity
nbn...	Notifies your organisation of any required Non-Standard Installation activities or Delivery Prerequisites. Charges for Non-Standard Installations may apply.
Your organisation...	<i>(If Delivery Prerequisites are required)</i> Your organisation or the End User will need to arrange for the completion of these activities before nbn will complete the order.

4.5 Build Activities

If Build Activities are required as a precursor to Delivery, then:

Who	Activity
nbn...	Will conduct the Build Activities under and in accordance with the Build Agreement.

Who	Activity
nbn...	Will update your organisation under and in accordance with the Build Agreement as Build Activities progress through different stages.

4.6 Manage Delivery Completions

nbn will issue a Completed Notification when **nbn** successfully connects and activates the Ordered Product. See section [4.8.1.5 Order Status Life-cycle](#)

4.7 Products

4.7.1 Product Components: Ordering Sequence

Prerequisite: Your organisation will require physical access to an Established POI for certain Infrastructure Components (e.g. **nbn**TM Building Entry Service, ODF Termination, Co-location and Cross Connects) before your organisation can order certain Product Components.

Please refer to the ***WBA Operations Manual***.

There may be significant lead times between your organisation placing an order for a Product Component and **nbn** commencing supply of that Product Component.



Important: **nbn** is not responsible for any delays in supplying Product Components to your organisation by reason of a failure by your organisation to take account of these lead times, which is an RSP Event for the purposes of the [WBA](#).

High-level Summary

The following diagram and description outline the high-level ordering sequence to which your organisation and **nbn** must adhere:

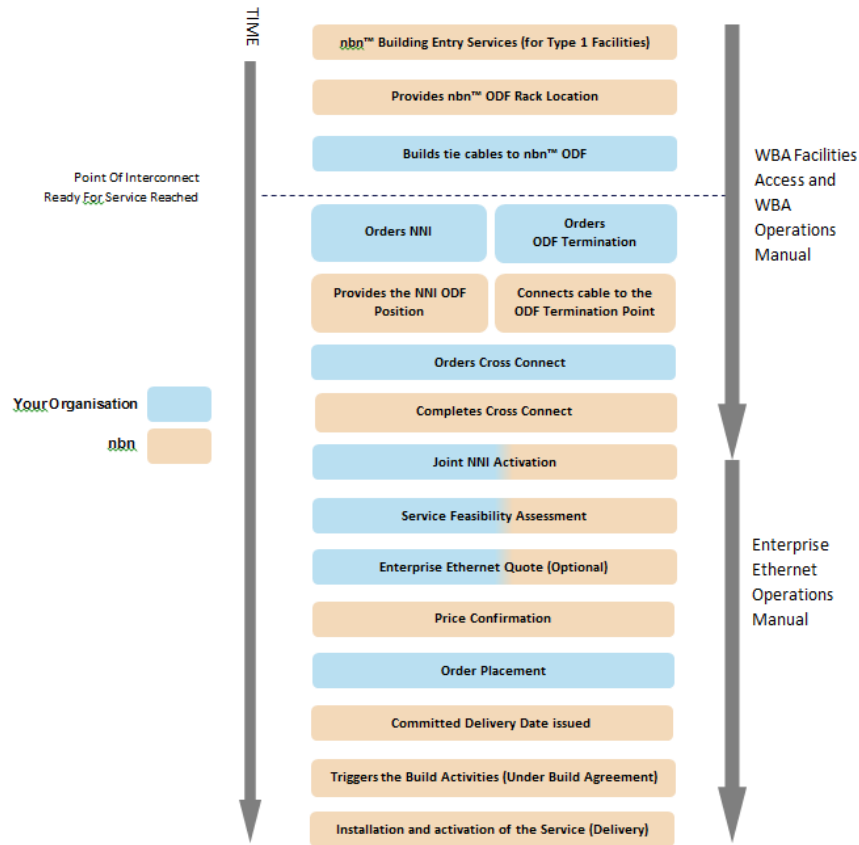

Order Sequence description

The steps for Order placement, and the associated activities **nbn** and your organisation must perform, are defined in the table below.

Note: for steps relating to the ordering and provisioning of the NNI, including NNI-Link and V-NNI– refer to the **WBA Operations Manual**.

Who	Activity
Your organisation...	Orders the UNI-E.
Your organisation...	Orders the OVC (including the selection of the bandwidth profile and Classes of Service).
nbn...	Delivers the nbn™ Enterprise Ethernet Ordered Product.

Does this mean that for each OVC, my organisation must place an order for each/all of the other Product Components of nbn™ Enterprise Ethernet as well?

No. The above diagram illustrates the sequence in which to order and connect Product Components; not the quantities. Your organisation may (for example) order multiple OVCs to connect to a single UNI-E. For a detailed description, refer to the [nbn™ Enterprise Ethernet Product Description](#).

4.8 Orders

4.8.1 About Orders

4.8.1.1 Ordering Product Components

Your organisation can order all Product Components of **nbn**[™] Enterprise Ethernet through the **nbn**[™] Enterprise Ethernet Portal or via B2B Access with the exception of the NNI (or a V-NNI as applicable), which must be ordered in accordance with the **WBA Operations Manual** through the **nbn**[™] Service Portal.

Order Types

The following table outlines the three types of order:

Order Type	Description
Connect Order	A request for the installation and/or configuration of a Product Component. Charges may apply.
Modify Order	A request for modifications to an existing installed/configured Product Component. Charges may apply.
Disconnect Order	A request to disconnect an existing installed/configured Product Component. Charges may apply.

Your organisation can place the following order types for each of the following Product Components:

Product Component	Order Type	Order via ...
Operator Virtual Connection (OVC) (Includes additional OVC Product Features ordered)	<ul style="list-style-type: none"> Connect Order Modify Order Disconnect Order 	<ul style="list-style-type: none"> nbn[™] Enterprise Ethernet Portal or B2B Access
User Network Interface (UNI)	<ul style="list-style-type: none"> Connect Order Modify Order Disconnect Order 	<ul style="list-style-type: none"> nbn[™] Enterprise Ethernet Portal or B2B Access

Related document: **nbn**[™] *Enterprise Ethernet Price List* available from **nbn**'s Website.

4.8.1.2 Amending Orders

Your organisation may, via the **nbn**[™] Enterprise Ethernet Portal or B2B Access, make some amendments to an order, which relate to non-price impacting order changes only.

The attributes of an order which can be amended are set out in the **nbn**[™] Enterprise Ethernet Operations User Guide.

To the extent (if any) that orders can be amended, your organisation may only make amendments before the order has been assigned with a Committed Delivery Date, following which **nbn** is not obliged to accept any order amendments.

4.8.1.3 Cancelling Orders

Your organisation can cancel an order, by placing a cancellation request through the **nbn**[™] Enterprise Ethernet Portal or via B2B Access, until the following date:

- (if **nbn** has not notified your organisation of an updated delivery date), 1 Business Day prior to the Committed Delivery Date; or
- (if **nbn** has notified your organisation of an updated delivery date), 1 Business Day prior to the updated delivery date.

4.8.1.4 Order Enquiry

Your organisation may submit an Order Enquiry through the order’s ‘Comments’ section via the **nbn**™ Enterprise Ethernet Portal.

4.8.1.5 Order Status Life-cycle

The following diagram illustrates the life-cycle of an order including the different Order Status states that may apply:

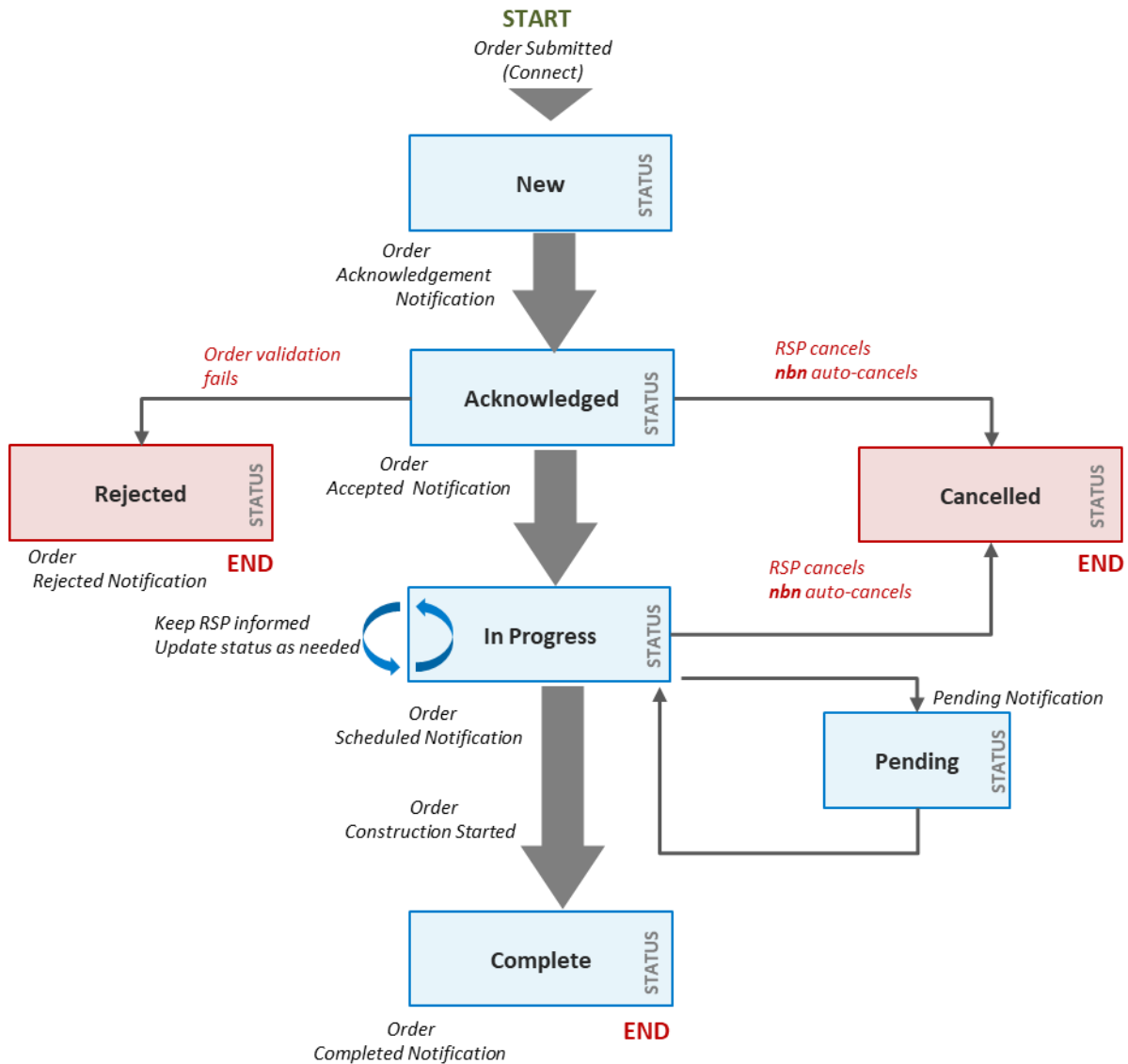

Order Status: Descriptions

The following table defines the different Order Status (as illustrated by reference to a Connect Order) states that apply to an order, the Product Components to which they apply and the related activities which must be performed by **nbn** or your organisation in those circumstances.

These activities must be performed once the relevant event set out in the table occurs.

Order Status	Affected Product Component types	Related event & activities
New	<ul style="list-style-type: none"> Product Component 	<p>Event</p> <p>Your organisation has placed the order with nbn</p>
Acknowledged	<ul style="list-style-type: none"> Product Component 	<p>Event</p> <p>Order received by nbn</p> <p>Activities</p> <ul style="list-style-type: none"> nbn reviews the order for acceptability and adherence to the WBA. nbn allocates a unique Order ID nbn will then accept or reject the order.
In Progress	<ul style="list-style-type: none"> Product Component 	<p>Event</p> <p>No issues encountered</p> <p>Your organisation has complied with all requirements of the WBA necessary to progress the order</p> <p>Installation/activation process commences.</p> <p>Activities</p> <ul style="list-style-type: none"> nbn updates the order status to In Progress nbn sends an Order Accepted Notification to your organisation nbn assigns a Product Instance ID to the Ordered Product Component. <p>This includes order details as described in the section below headed Order Accepted Notifications: Additional Product Component Information.</p>
Pending	<ul style="list-style-type: none"> Product Component 	<p>Event</p> <p>One of the following:</p> <ul style="list-style-type: none"> nbn considers that it has insufficient information to fulfil an order Your organisation has not taken all actions necessary to progress the order or comply with the WBA. <p>Activities</p> <ul style="list-style-type: none"> nbn updates the order status to Pending nbn sends a Pending Notification to your organisation nbn includes details of the information that your organisation must provide to nbn, or action that your organisation must take, for successful validation. <p>Your organisation:</p> <ul style="list-style-type: none"> Must provide information and/or take the requested action within 10 Business Days of receiving the Pending Notification (unless otherwise provided for in this nbn™ Enterprise Ethernet Operations Manual or agreed with nbn) May add comments to the related Product Order Form's "comments" field during the relevant time period referred to immediately above, which may include a request for an extension with supporting details. <p>The order remains Pending until one or more of the following circumstances:</p>

Order Status	Affected Product Component types	Related event & activities
		<ul style="list-style-type: none"> • nbn considers that it has the required information to proceed • your organisation has taken the requested action • your organisation or nbn Cancels the order.
Complete	<ul style="list-style-type: none"> • Product Component 	<p>Event</p> <p>nbn successfully connects and activates the Ordered Product Component. nbn commences charging in accordance with clause B1.2 of the Head Terms.</p> <p>Activities</p> <ul style="list-style-type: none"> • nbn updates the order status to Complete • The related Product Instance ID becomes active • nbn sends a Completed Notification to your organisation.
Rejected	<ul style="list-style-type: none"> • Product Component 	<p>Event</p> <p>nbn reasonably determines that the order is invalid or cannot be completed, due to one or more of the following circumstances:</p> <ul style="list-style-type: none"> • Your organisation has not complied with Product-specific ordering terms or requirements • The order is not submitted in accordance with the requirements, restrictions or other processes set out in the WBA, including this nbnTM Enterprise Ethernet Operations Manual • A Stop Sell Period currently applies to the ordered Product, Product Component or Product Feature and the order is not a Transition-out Modify Order or Disconnect Order • The order fails nbn's feasibility and design and/or configuration phase • nbn has, acting reasonably, determined it is not viable to proceed with the order • The order does not include a valid Customer Authority (where required) • The order fails to meet the Business Rules in respect of the relevant Product Component • The order is otherwise defective • The relevant Build Agreement with your organisation has been terminated or expired (where relevant). <p>Activities</p> <ul style="list-style-type: none"> • nbn updates the order status to Rejected • nbn sends a Rejected Notification to your organisation • nbn provides your organisation with reasons for rejecting the order (located in the order's "comments" field).
Cancelled	<ul style="list-style-type: none"> • Product Component 	<p>Event</p> <p>Occurs in the following situations:</p> <ul style="list-style-type: none"> • Your organisation submits a cancellation request in accordance with section 4.8.1.3 Cancelling Orders • The order is not submitted in accordance with the method outlined in this nbnTM Enterprise Ethernet Operations Manual or the WBA

Order Status	Affected Product Component types	Related event & activities
		<ul style="list-style-type: none"> • A Stop Sell Period currently applies to the ordered Product, Product Component or Product Feature and the order is not a Transition-out Modify Order or Disconnect Order • Your organisation fails to provide the requested information, or take any required action, to allow an order to proceed, within the timeframes required by nbn • nbn is aware, or reasonably considers, that your organisation does not have a valid Customer Authority (where required) • The Committed Delivery Date is not acceptable to your organisation • nbn has attempted to access a site in good faith 3 times or more and has been unable to secure access • nbn has, acting reasonably, determined it is not viable to proceed with the order • Any Build Activities associated with the order have been cancelled under the relevant Build Agreement with your organisation • The relevant Build Agreement with your organisation has been terminated or expired (where relevant). • <u>nbn is not able to reach an acceptable arrangement with the relevant Upstream Service Provider (including, without limitation, in relation to rack space leasing and datacentre access terms)</u> <p>Activities</p> <ul style="list-style-type: none"> • nbn updates the order status to Cancelled • nbn sends a Cancelled Notification to your organisation.

Order Accepted Notifications: Additional Product Component Information

Once an order has been Acknowledged by **nbn**, the order is validated and an Order Accepted Notification will be sent to your organisation. The Order Accepted Notification will include the following information about your organisation’s order for the following Product Components or **nbn**™ Equipment:

Product Component /nbn™ Equipment ordered	Information supplied in the Order Accepted Notification
OVC	<ul style="list-style-type: none"> • Order ID • Product Instance ID • Service ID • OVC ID • OVC S-TAG value confirmation/assignment.
UNI	<ul style="list-style-type: none"> • UNI Port ID • Product Instance ID • UNI ID
B-NTD	<ul style="list-style-type: none"> • B-NTD ID

4.8.2 Modifications

Your organisation may make modifications to some of the features or current configuration of existing **nbn**[™] Enterprise Ethernet Ordered Products, by placing a Modify Order through the **nbn**[™] Enterprise Ethernet Portal or via B2B Access or by raising a Service Request via the **nbn**[™] Service Portal. Modifications in relation to the NNI must be initiated via a Modify Order or Service Request through the **nbn**[™] Service Portal.

When submitting a Modify Order through the **nbn**[™] Enterprise Ethernet Portal or via B2B Access, your organisation may request that certain modifications be performed between the hours of 9:00pm and 7:00am.

Section [4.8.2.1 Permitted Modifications to Product Components](#) below sets out limits and supporting notes on permitted modifications.



Important: When placing a Modify Order, your organisation must always provide the Product Instance ID for the associated Product Component.

4.8.2.1 Permitted Modifications to Product Components

The following table describes the modifications your organisation is permitted to make and supporting notes.

Method	Allowable Modifications and supporting notes
Modify Order via nbn[™] Enterprise Ethernet Portal or via B2B Access	<ul style="list-style-type: none"> • Add an OVC to an existing UNI-E* • Delete an OVC from an existing UNI-E* • Modification of an OVC-Type for an existing UNI-E* (as described in the nbn[™] Enterprise Ethernet Product Technical Specification) • Modification of an S-VLAN-ID for an existing OVC* (as described in the nbn[™] Enterprise Ethernet Product Technical Specification) • Modification of the TPID for an existing UNI-E* (as described in the nbn[™] Enterprise Ethernet Product Technical Specification) • Modification of a Premium Assurance Service Level option* • Modification of an OVC bandwidth profile* • Modification of Class of Service* • Modification of an UNI VLAN-ID (as described in the nbn[™] Enterprise Ethernet Product Technical Specification)* • Any other modification that nbn makes available from time to time through the nbn[™] Enterprise Ethernet Portal or via B2B Access <p><i>For any allowable modification</i></p> <p>There may be a brief service interruption (typically lasting less than 1 minute) when the Modify Order is processed. Except as set out below, Modify Orders of this nature are usually processed by nbn within 10 minutes after your organisation places the order. This brief service interruption is not an Outage or an Enterprise Ethernet Fault.</p> <p>* Note: For these types of modifications, your organisation may request through the nbn[™] Enterprise Ethernet Portal or via B2B Access that nbn perform the modification between the hours of 9:00pm and 7:00am. nbn may also make this option available in respect of other types of modifications through the nbn[™] Enterprise Ethernet Portal or via B2B Access.</p>
Service Request via nbn[™] Service Portal	<ul style="list-style-type: none"> • Change of Power Supply Unit (AC to DC or DC to AC) • Addition or removal of dual Power Supply Unit • Relocation or mounting option of B-NTD

4.8.2.2 Interactions: Modify Order

The following diagram illustrates the interactions between your organisation and **nbn** that can arise from the submission of a Modify Order.

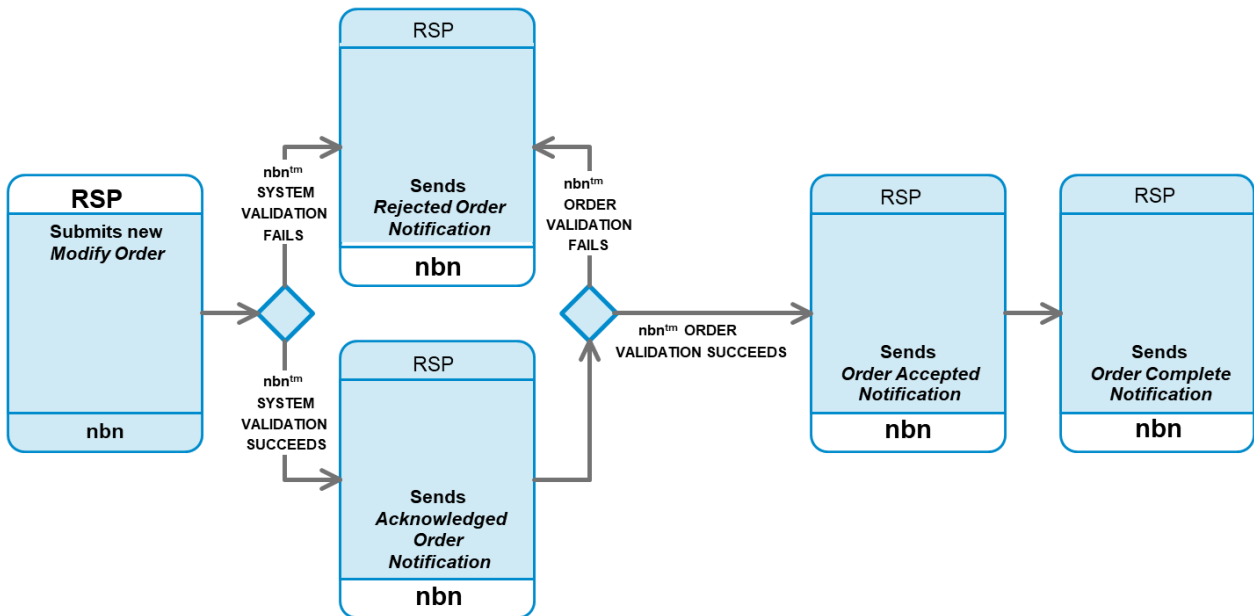

Description

The following table describes the interaction activities between your organisation and **nbn** that can arise from the submission of a Modify Order.

If your organisation is using the **nbn**™ Enterprise Ethernet Portal, then:

Who	Activity
Your organisation...	Begins the Modify Order by submitting required information in the nbn ™ Enterprise Ethernet Portal
nbn...	Provides your organisation with pricing information to review
Your organisation...	Submits a Modify Order against a completed Product order
nbn...	Confirms that the Modify Order was submitted correctly and depending on the result of the submission validation, does one of the following: <ul style="list-style-type: none"> (If the Modify Order was submitted correctly) Sends your organisation an Acknowledged Notification and updates the Order Status to Acknowledged The notification includes the Product order’s unique Order ID. <ul style="list-style-type: none"> (If the Modify Order was not submitted correctly) Sends your organisation a Rejected Notification if nbn rejects the order and updates the Order Status to Rejected.
nbn...	(If the Modify Order was submitted correctly) Confirms that the specific information provided in the Modify Order is sufficient to proceed with the order and, depending on the result of this validation, does one of the following: <ul style="list-style-type: none"> (If nbn determines that the Modify Order is valid) Sends your organisation an Order Accepted Notification and updates the Order Status to In Progress The notification includes the Product order’s unique Order ID.

Who	Activity
	<ul style="list-style-type: none"> (If nbn determines that the Modify Order is not valid) Sends your organisation a Rejected Notification and updates the Order Status to Rejected.
nbn...	(On completion of the ordered modification of services and resources, and subsequent successful testing of the modifications) Sends your organisation a Completed Notification and updates the Order Status to Complete .

If your organisation is using B2B Access then:

Who	Activity
Your organisation...	Submits a Modify Order against a completed Product order via B2B Access
nbn...	<p>Confirms that the Modify Order was submitted correctly and depending on the result of the submission validation, does one of the following:</p> <ul style="list-style-type: none"> (If the Modify Order was submitted correctly) Sends your organisation an Acknowledged Notification and updates the Order Status to Acknowledged <p>The notification includes the Product order's unique Order ID.</p> <ul style="list-style-type: none"> (If the Modify Order was not submitted correctly) Sends your organisation a Rejected Notification if nbn rejects the order and updates the Order Status to Rejected.
nbn...	<p>(If the Modify Order was submitted correctly) Confirms that the specific information provided in the Modify Order is sufficient to proceed with the order and, depending on the result of this validation, does one of the following:</p> <ul style="list-style-type: none"> (If nbn determines that the Modify Order is valid) Sends your organisation an Order Accepted Notification and updates the Order Status to In Progress <p>The notification includes the Product order's unique Order ID.</p> <p>(If nbn determines that the Modify Order is not valid) Sends your organisation a Rejected Notification and updates the Order Status to Rejected.</p>
nbn...	(On completion of the ordered modification of services and resources, and subsequent successful testing of the modifications) Sends your organisation a Completed Notification and updates the Order Status to Complete .

4.8.3 Disconnect Orders

If your organisation wishes to disconnect all or part of an **nbn**TM Enterprise Ethernet Ordered Product, your organisation must place a Disconnect Order through the **nbn**TM Enterprise Ethernet Portal or via B2B Access with the exception of the NNI, in which case the Disconnect Order must be placed through the **nbn**TM Service Portal.

Order Information

Disconnect Orders must (at the very least) include all of the following:

- A valid Product Instance ID for the Product Component to be disconnected

Note: On disconnection, the Product Instance ID may be deleted by **nbn**.

- All of the information required by the fields in the relevant Disconnect Order form.

Once **nbn** validates a Disconnect Order, **nbn** will process it in accordance with the order stages as described in section [4.8.1.5 Order Status Life-cycle](#)

Prerequisites for Disconnect Orders

For each of the following Product Components, your organisation must make sure that the applicable disconnection prerequisites below have been met before submitting a Disconnect Order for the Product Component:

Product component	Disconnection prerequisites
Network-Network Interface (NNI)	<p>nbn has received a valid Disconnect Order, and has completed the Disconnect Order for all associated OVCs (and all associated Product Components where the NNI is shared across nbnTM Products).</p> <p>Note: Where the NNI is a Linked NNI, nbn has also completed the Modify Order to remove all associated NNI Links.</p>

Important: A request to disconnect a UNI, will in turn trigger a disconnection of the associated OVCs.

Important: If **nbn** disconnects all OVCs associated to a UNI in response to a Disconnect Order, **nbn** will simultaneously disconnect the associated UNI.

4.8.3.1 Interactions: Disconnect Order

The following diagram illustrates the interactions between your organisation and **nbn** that can arise from the submission of a Disconnect Order.

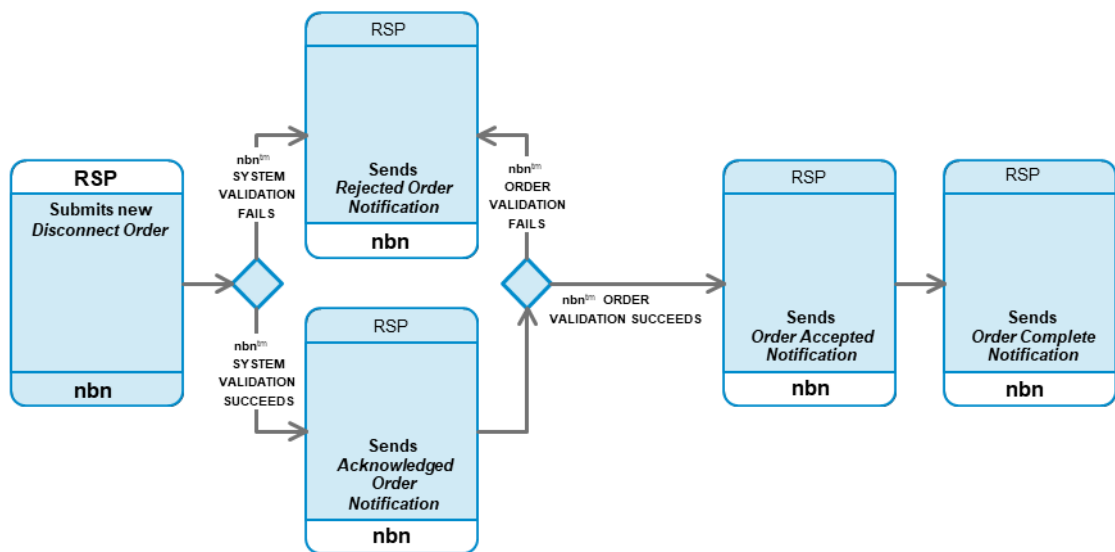

Description

The following table describes the interaction activities between your organisation and **nbn** that can arise from the submission of a Disconnect Order.

Who	Activity
Your organisation...	Submits a Disconnect Order (via the nbn TM Enterprise Ethernet Portal or via B2B Access) against a completed Product order.
nbn...	Confirms that the Disconnect Order was submitted correctly and depending on the result of the submission validation, does one of the following:

Who	Activity
	<ul style="list-style-type: none"> (If the Disconnect Order was submitted correctly) Sends your organisation an Acknowledged Notification and updates the Order Status to Acknowledged <p>The notification includes the Product order's unique Order ID.</p> <p>Note: Your organisation may cancel the order at this time.</p> <ul style="list-style-type: none"> (If the Disconnect Order was not submitted correctly) Sends your organisation a Rejected Notification if nbn rejects the order and updates the Order Status to Rejected.
nbn...	<p>(If the Disconnect Order was submitted correctly) Confirms that the specific information provided in the Disconnect Order is sufficient to proceed with the order and, depending on the result of this validation, does one of the following:</p> <ul style="list-style-type: none"> (If nbn determines that the Disconnect Order is valid) Sends your organisation an Order Accepted Notification and updates the Order Status to In Progress <p>The notification includes the Product order's unique Order ID.</p> <ul style="list-style-type: none"> (If nbn determines that the Disconnect Order is not valid) Sends your organisation a Rejected Notification and updates the Order Status to Rejected.
nbn...	<p>(On disconnection of the specified services and resources, and the subsequent successful disconnection test)</p> <ul style="list-style-type: none"> Sends your organisation a Completed Notification and updates the Order Status to Complete. nbn may charge your organisation – see the nbn™ Enterprise Ethernet Price List <p>Note: The disconnection is effective at this point for the purposes of the definition of Effective Disconnection Date.</p>

4.8.4 Same POI Migration Orders

Your organisation may submit a Same POI Migration Order to migrate one or more OVCs in respect of **nbn™** Enterprise Ethernet between NNIs at the same POI.

A **Same POI Migration Order** is a Modify Order for the migration (as specified in section [4.8.4.2 Same POI Migration Orders: Interactions](#)) of one or more OVCs where the originating POI location and destination POI location are the same.

4.8.4.1 Same POI Migration Order Activities

A Same POI Migration Order may be used to undertake any of the following activities:

Activity	Description of activity
Migrate a single OVC	The migration of a single OVC from one NNI to another NNI at the same POI.
Bulk migration of OVCs	The migration in bulk of multiple OVCs from one NNI to another NNI at the same POI.



Important: There will be a brief service interruption (typically lasting less than 1 minute) when the Same POI Migration Order is processed in respect of an OVC migration. This brief service interruption is not an Outage or a Service Fault.

4.8.4.2 Same POI Migration Orders: Interactions

The following table describes the interactions that may occur when placing a Same POI Migration Order in respect of one or more OVCs:

Who	Activity
Your organisation...	Submits a Same POI Migration Order for the OVC migration using the nbn ™ Enterprise Ethernet Portal. Note: Where nbn considers it to be appropriate, nbn will work with your organisation to complete bulk migration of OVCs within a migration slot requested by your organisation.
nbn...	Completes the Same POI Migration Order in respect of the specified OVC(s) by migrating each OVC one at a time, to the new designated NNI.

4.8.4.3 Same POI Migration Order Life Cycle

The following diagram illustrates the life-cycle of a Same POI Migration Order for the migration of a single OVC, or one or more OVCs, including the different Order Status states that may apply:

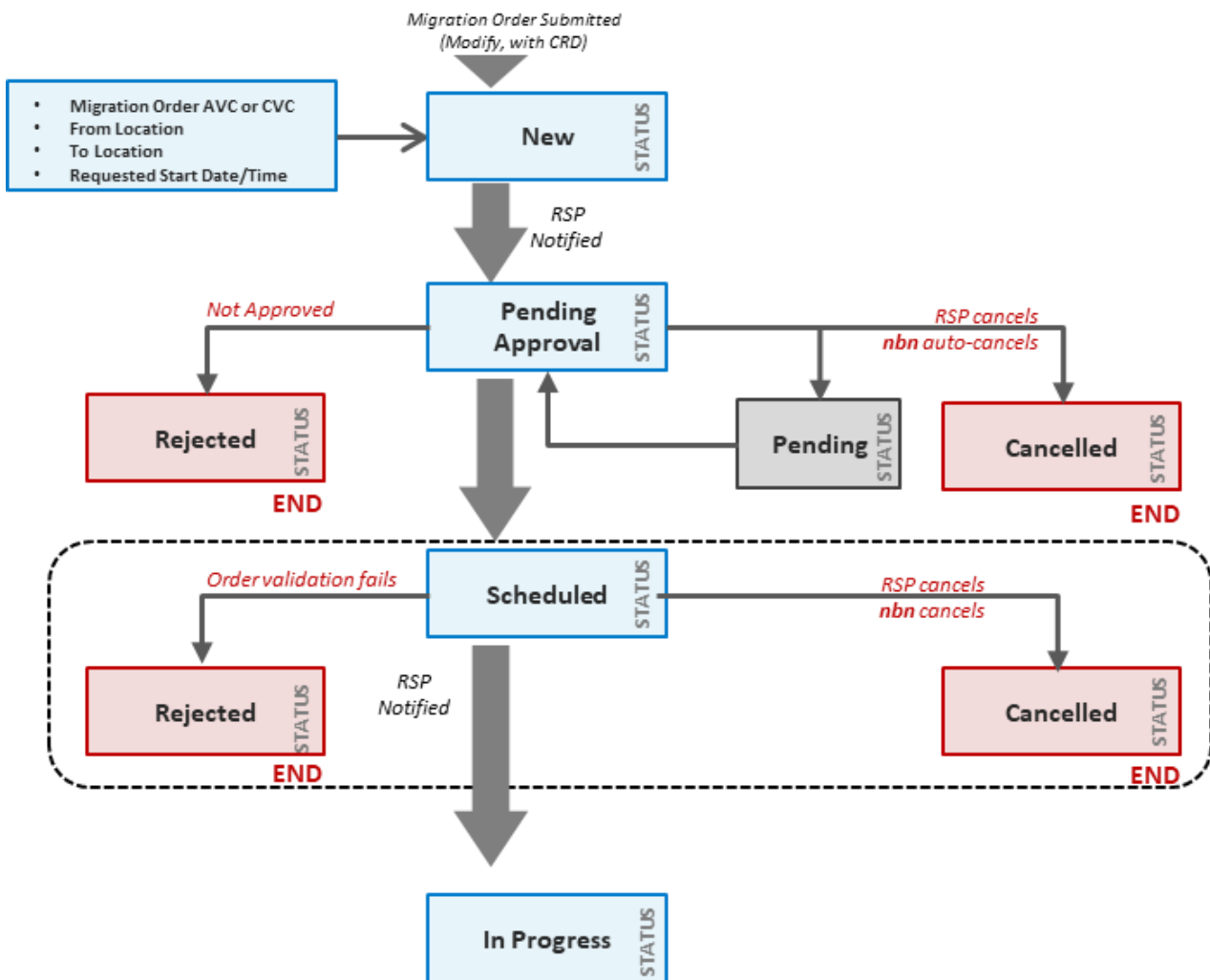

Same POI Migration Orders are subject to the standard Order Status states described in section 4.8.1.5 Order Status Life-cycle except as set out below.

Additional Order Status states of "Pending Approval" and "Scheduled" apply for Same POI Migration Orders.

Order Status: Descriptions

The following table defines the Product Components to which "Pending Approval" and "Scheduled" Order Status can apply and the related activities which must be performed by **nbn** or your organisation in each circumstance.

These activities must be performed once the relevant event set out in the table occurs.

Order Status	Relevant event & activities
<p>Pending Approval</p>	<p>Event</p> <p>Your organisation has placed a Same POI Migration Order with nbn with the following attributes:</p> <ul style="list-style-type: none"> • One or more OVCs • Requested Start Date/Time <p>For POI location:</p> <ul style="list-style-type: none"> • Originating POI location • Destination POI location (must be same as Originating POI location) • Originating NNI • Destination NNI <p>Activities</p> <p>nbn has received the Same POI Migration Order and will review the order and if approved will schedule the order.</p> <div style="background-color: #fff9c4; padding: 10px; margin-top: 10px;"> <p> Important: The Requested Start Date/Time in respect of a Same POI Migration Order must be at least 15 Business Days after the date on which your organisation places the Same POI Migration Order.</p> <p>If your organisation requests a start date/time that does not comply with this requirement, nbn will work with your organisation to agree an alternative start date/time, place the Same POI Migration Order in a "Scheduled" Order Status, and will not process it further until that start date/time.</p> </div>
<p>Scheduled</p>	<p>Event</p> <p>Your organisation has placed a Same POI Migration Order with nbn and nbn has determined that the order can be scheduled at on the date your organisation requested in the order or another date agreed with your organisation.</p> <p>Activities</p> <p>nbn schedules the Same POI Migration Order and will not process it further until the Requested Start Date/Time.</p>

 **Important:** If your organisation requests an OVC migration as a Same POI Migration Order and **nbn** determines that the Requested Start Date/Time is not available, or if your organisation does not provide a Requested Start Date/Time, **nbn** will work with your organisation to agree a start date/time, place the Same POI Migration Order in a "Scheduled" Order Status and will not process it further until that start date/time.

4.8.5 Local/State POI Migration Order

Your organisation may submit a Local/State POI Migration Order to migrate one or more OVCs in respect of **nbn**TM Enterprise Ethernet:

- from an NNI at a Local POI to an NNI at the relevant State Aggregation POI; or
- from an NNI at a State Aggregation POI to an NNI at the relevant Local POI.

A Local/State POI Migration Order is a Modify Order for the migration (as specified in section [4.8.5.2 Local/State POI Migration Order: Interactions](#)) of one or more OVCs where the originating POI location and destination POI location are changed:

- from an NNI at a Local POI to an NNI at the relevant State Aggregation POI; or

from an NNI at a State Aggregation POI to an NNI at the relevant Local POI.

When your organisation places a Local/State POI Migration Order, your organisation is deemed to be:

in the case of an OVC migration from a Local POI to a State Aggregation POI, placing a Modify Order to acquire Route Aggregation in respect of each OVC to be migrated; or

in the case of an OVC migration from a State Aggregation POI to a Local POI, placing a Modify Order to remove Route Aggregation from each OVC to be migrated.

See the [nbn™ Enterprise Ethernet Price List](#) for details of the Charges which may apply for Route Aggregation.

4.8.5.1 Local/State POI Migration Order Activities

A Local/State POI Migration Order may be used to undertake any of the following activities:

Activity	Description of activity
Migrate a single OVC	The migration of a single OVC from one NNI at a Local POI to an NNI at the relevant State Aggregation POI; or from one NNI at a State Aggregation POI to an NNI at the relevant local POI.
Bulk migration of OVCs	The migration in bulk of multiple OVCs from one NNI at a Local POI to an NNI at the relevant State Aggregation POI; or from one NNI at a State Aggregation POI to an NNI at the relevant Local POI



Important: There will be a brief service interruption (typically lasting less than 1 minute) when the Local/State POI Migration Order is processed in respect of an OVC migration. This brief service interruption is not an Outage or a Service Fault.

4.8.5.2 Local/State POI Migration Order: Interactions

- The following table describes the interactions that must occur when placing a Local/State POI Migration Order in respect of one or more OVCs:

Who	Activity
Your organisation...	(For OVC migrations from a Local POI to a State Aggregation POI) Begins the order process by confirming the applicable Route Type for the OVCs to be migrated via the nbn™ Enterprise Ethernet Portal.
Your organisation...	Submits a Local/State POI Migration Order for the OVC migration using the nbn™ Enterprise Ethernet Portal. Note: Where nbn considers it to be appropriate, nbn will work with your organisation to complete bulk migration of OVCs within a migration slot requested by your organisation.
nbn...	Validates that the Local/State POI Migration Order has been submitted correctly for meeting the business rules for order submission and depending on the result of the submission validation, does one of the following: <i>(If the Local/State POI Migration Order is not valid)</i> Sends your organisation a Rejected Notification and updates the Order Status to Rejected <i>(If the Local/State POI Migration Order is valid)</i> Completes the Local/State POI Migration Order in respect of the specified OVC(s) by migrating each OVC one at a time, to the new designated NNI at the relevant POI.

4.8.5.3 Local/State POI Migration Order Life Cycle

The following diagram illustrates the life-cycle of a Local/State POI Migration Order for the migration of a single OVC, or one or more OVCs, including the different Order Status states that may apply:

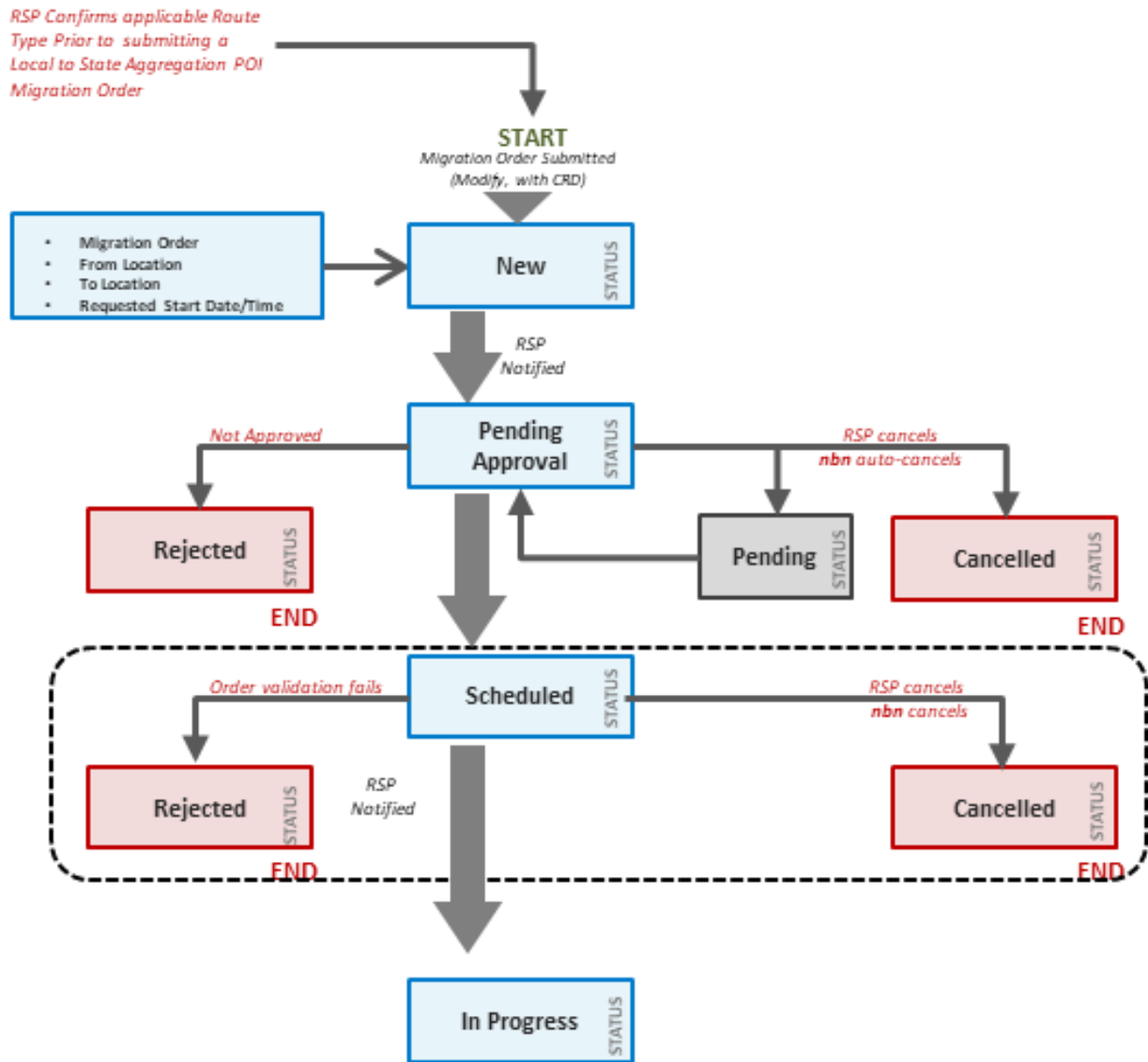

Local/State POI Migration Orders are subject to the standard Order Status states described in section 4.8.1.5 [Order Status Life-cycle](#) except as set out below.

Additional Order Status states of “Pending Approval” and “Scheduled” apply for Local/State POI Migration Orders.

Order Status : Descriptions

The following table defines the Product Components to which “Pending Approval” and “Scheduled” Order Status can apply and the related activities which must be performed by **nbn** or your organisation in each circumstance.

These activities must be performed once the relevant event set out in the table occurs.

Order Status	Relevant event & activities
Pending Approval	<p>Event</p> <p>Your organisation has placed a Local/State POI Migration Order with nbn with the following attributes:</p> <p>One or more OVCs</p>

Order Status	Relevant event & activities
	<p>Requested Start Date/Time</p> <p>For POI location:</p> <p>Originating POI location</p> <p>Destination POI location</p> <p>Originating NNI</p> <p>Destination NNI</p> <p>Activities</p> <p>nbn has received the Local/State POI Migration Order and will review the order and if approved will schedule the order.</p> <div style="background-color: #fff9c4; padding: 10px; margin-top: 10px;">  <p>Important: The Requested Start Date/Time in respect of a Local/State POI Migration Order must be at least 15 Business Days after the date on which your organisation places the Local/State POI Migration Order.</p> <p>If your organisation requests a start date/time that does not comply with this requirement, nbn will work with your organisation to agree an alternative start date/time, and place the Order in a "Scheduled" Order Status, and will not process it further until that start date/time.</p> </div>
<p>Scheduled</p>	<p>Event</p> <p>Your organisation has placed a Local/State POI Migration Order with nbn and nbn has determined that the order can be scheduled on the date your organisation requested in the order or another date agreed with your organisation.</p> <p>Activities</p> <p>nbn schedules the Local/State POI Migration Order and will not process it further until the Requested Start Date/Time.</p>



Important: If your organisation requests an OVC migration as a Local/State POI Migration Order and **nbn** determines that the Requested Start Date/Time is not available, or if your organisation does not provide a Requested Start Date/Time, **nbn** will work with your organisation to agree a start date/time, place the Local/State POI Migration Order in a "Scheduled" Order Status and will not process it further until that start date/time.

Module 5: Assurance

5.1 In This Module

This module describes the processes and interactions that apply to assurance of the **nbn**TM Enterprise Ethernet Product with regard to:

- Logging, validating, diagnosing, prioritising and assigning Trouble Tickets and managing field work (for physical fault management) to resolve and close Trouble Tickets.
- Responsibilities of your organisation when raising and updating Trouble Tickets.

5.2 Log Trouble Ticket

Who	Activity
Your organisation...	Performs testing and troubleshooting with End User
Your organisation...	Follows your internal processes to resolve any issues on your organisation's network
Your organisation...	Checks for existing network incidents or Planned Outages on the nbn TM Enterprise Ethernet Portal or B2B Access.
Your organisation...	Determines if a new Trouble Ticket needs to be raised to nbn
Your organisation...	Logs into the nbn TM Enterprise Ethernet Portal or B2B Access to raise a new Trouble Ticket. If the nbn TM Enterprise Ethernet Portal or B2B Access is unavailable, then your organisation may raise a Trouble Ticket by telephoning the relevant RSP Support Centre contact address in the <i>Contact Matrix</i> .

Refer to section [5.3.2 Trouble Tickets](#) in regard to using the **nbn**TM Enterprise Ethernet Portal or B2B Access to raise Trouble Tickets.

5.3 RSP-Reported Fault Rectification



Important Trouble Tickets must not be raised prior to following each applicable process set out in this **nbn**TM Enterprise Ethernet Operations Manual. See section:5.3.2 Trouble Tickets

When your organisation becomes aware of a potential fault, affecting an Ordered Product it must (as soon as reasonably practicable) perform the test and diagnostic tasks specified in the *EE Test & Diagnostic Checklist* to identify whether or not the fault is likely to be an Enterprise Ethernet Fault.

Following this evaluation, your organisation must (as soon as reasonably practicable) raise a Trouble Ticket for the fault if (based on the results of the diagnostic tasks and test specified in the *EE Test & Diagnostic Checklist*) your organisation reasonably considers that the fault is an Enterprise Ethernet Fault.

Note: When your organisation has ordered a V-NNI, it must, prior to raising a Trouble Ticket in respect of an actual or potential Enterprise Ethernet Fault, contact the relevant NNI Link RSP and confirm that the fault is not related to backhaul or the Linked NNI.

If a fault relates to the Linked NNI, the relevant NNI Link RSP should raise a Trouble Ticket

For the avoidance of doubt, if the fault relates to a Type 2 Facility, your organisation must only contact **nbn**, and not an Underlying Facility Provider, regarding the fault.

5.3.1 Test & Diagnostics

The **nbn**[™] Enterprise Ethernet Portal or B2B Access will provide test and diagnostics tools of the type detailed in this section [5.3.1 Test & Diagnostics](#).

Your organisation should refer to the *EE Test & Diagnostic Checklist* and the *EE Test & Diagnostics Guide* (provided to your organisation) when reviewing the results of Diagnostic Status Tests and Network Tests.

Your organisation must follow the T&D requirements as specified when raising a new Trouble Ticket, otherwise the Trouble Ticket could be Rejected.

The *EE Test & Diagnostics Guide* is a companion document which focuses on how to use **nbn**[™] test & diagnostic tools, and how to interpret the test and diagnostic results.
 Your organisation can obtain a copy of the latest release of the *EE Test & Diagnostics Guide* by contacting the **nbn** Relationship Point of Contact.

 **Important:** The *EE Test & Diagnostic Checklist* and *EE Test & Diagnostics Guide* do not form part of this document or the [WBA](#).

5.3.1.1 Diagnostic Status Tests

Your organisation may submit a request for a Diagnostic Status Test through the **nbn**[™] Enterprise Ethernet Portal or B2B Access.

The following table defines the different Test Status states that apply to a Diagnostic Status Test:

Test Status	Related Events and Activities
New	The request for a Diagnostic Status Test has been submitted.
Complete	The Diagnostic Status Test is complete.
Incomplete	A problem was encountered when conducting the Diagnostic Status Test.

5.3.1.2 Network Tests

Your organisation may submit a request for a Network Test through the **nbn**[™] Enterprise Ethernet Portal or B2B Access.

When a Network Test reaches its Point of No Return, your organisation cannot cancel it.

The following diagram illustrates the lifecycle of a Network Test, including the Test Status states that may apply:

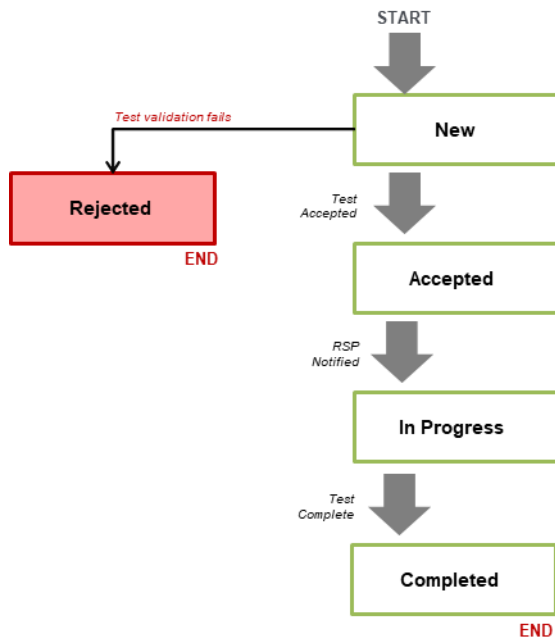

The following table defines the different Test Status states that apply to a Network Test.

Test Status	Related Events and Activities
New	The request for a Network Test has been submitted.
Accepted	<p>Event The Network Test request is received by nbn, with no issues encountered.</p> <p>Activities</p> <ul style="list-style-type: none"> • nbn updates the Test Status to Accepted • nbn provides a unique Test ID • nbn schedules the Network Test for execution
In Progress	<p>Event nbn commences Network Test execution</p> <p>Activities</p> <ul style="list-style-type: none"> • nbn updates the Test Status to In Progress • nbn performs the necessary Network Test activities
Complete	<p>Event nbn completes Network Test execution.</p> <p>Activities</p> <ul style="list-style-type: none"> • nbn updates the Test Status to Complete
Rejected	<p>Event nbn reasonably determines that the Network Test request is invalid due to one or more of the following circumstances:</p> <ul style="list-style-type: none"> • The Network Test request submitted includes invalid information • The Network Test request fails to meet the relevant Business Rules detailed in the <i>EE Test & Diagnostics Guide</i> • The Network Test request submitted is otherwise defective <p>Activities</p> <ul style="list-style-type: none"> • nbn updates the Test Status to Rejected • nbn provides your organisation with reasons for rejecting the Network Test.

5.3.2 Trouble Tickets

Trouble Ticket Status: Descriptions

Each Trouble Ticket will have a Trouble Ticket Status, as indicated by its current status message. The following table provides a high level explanation of each Trouble Ticket Status:

Status	Description
New	<ul style="list-style-type: none"> • Trouble Ticket is raised • Trouble Ticket successfully created in the nbnTM Enterprise Ethernet Portal or B2B Access • The Trouble Ticket awaits validation by nbn.
Rejected	<p>The Trouble Ticket was not valid for one or more of the following reasons:</p> <ul style="list-style-type: none"> • It was incomplete, (e.g. Trouble Ticket submission failed to attach T&D test results) • It included invalid information • It was submitted without your organisation first complying with the requirements as set out in the <i>EE Test & Diagnostics Checklist</i> • It was not submitted in accordance with this module • It failed to meet the Business Rules in respect of any relevant Ordered Product • It otherwise failed to comply with any requirement of the WBA. • nbn has a right to reject the Trouble Ticket under any other provision in the WBA
Acknowledged	<ul style="list-style-type: none"> • nbn has received and validated the Trouble Ticket. • nbn allocates a unique Trouble Ticket ID. <p>Note: Trouble Tickets may receive a Rejected Notification after an Acknowledged Notification has been sent if the Trouble Ticket failed ticket validation.</p>
Acknowledged – Pending	<p>Trouble Ticket awaits action from your organisation before nbn has sent your organisation an Accepted Notification. nbn stops acting on the Enterprise Ethernet Fault while the Trouble Ticket remains in this Trouble Ticket Status.</p> <p>nbn assigns a Trouble Ticket Status of Acknowledged – Pending to a Trouble Ticket if nbn requires additional information and/or action or assistance from your organisation for the Trouble Ticket to proceed.</p>
In Progress	<p>nbn diagnoses and rectifies the Enterprise Ethernet Fault.</p> <p>Note: If a Trouble Ticket’s Trouble Ticket Status is updated to In Progress at a subsequent stage, then nbn continues to investigate the Enterprise Ethernet Fault.</p>
In Progress – Pending	<p>Trouble Ticket awaits action from your organisation after nbn has sent your organisation an Accepted Notification. nbn stops acting on the Enterprise Ethernet Fault while the Trouble Ticket remains in this Trouble Ticket Status.</p> <p>nbn assigns a Trouble Ticket Status of In Progress - Pending to a Trouble Ticket if nbn requires additional information and/or action or assistance from your organisation for the Trouble Ticket to proceed.</p>
In Progress – Held	<p>Trouble Ticket awaits action from nbn before nbn continues to act on the Enterprise Ethernet Fault.</p> <p>Example: Delays in nbn attending a site due to bad weather.</p> <p>Where known, nbn will provide your organisation with a proposed rectification date for the Enterprise Ethernet Fault.</p>
Resolved	<p>One of the following circumstances has arisen:</p> <ul style="list-style-type: none"> • The Enterprise Ethernet Fault indicated in the Trouble Ticket has been resolved and will be Closed in accordance with Section 5.3.7 Resolving and Closing a Trouble Ticket • The Trouble Ticket submitted is not valid and will be marked as resolved and automatically Closed

Status	Description
	<ul style="list-style-type: none"> nbn has sent your organisation a More Information Required Notification and the timeframe for your organisation to provide any requested information or assistance has passed without response or action from your organisation, and the Trouble Ticket will be automatically closed.
Closed	<p>One of the following circumstances has arisen:</p> <ul style="list-style-type: none"> nbn has Resolved the Trouble Ticket and the Trouble Ticket has been Closed in accordance with Section 5.3.7 Resolving and Closing a Trouble Ticket nbn has been unable to access the Premises (see section 5.4.4 Trouble Ticket site visit – nbn cannot access the site) any applicable timeframe for acknowledgement has passed without response from your organisation.

5.3.2.1 Raising, Validating and Resolving a Trouble Ticket

5.3.2.2 Interactions: Raising a Trouble Ticket with nbn

The following diagram illustrates the interaction activities between **nbn** and your organisation that can arise from the raising of a Trouble Ticket.

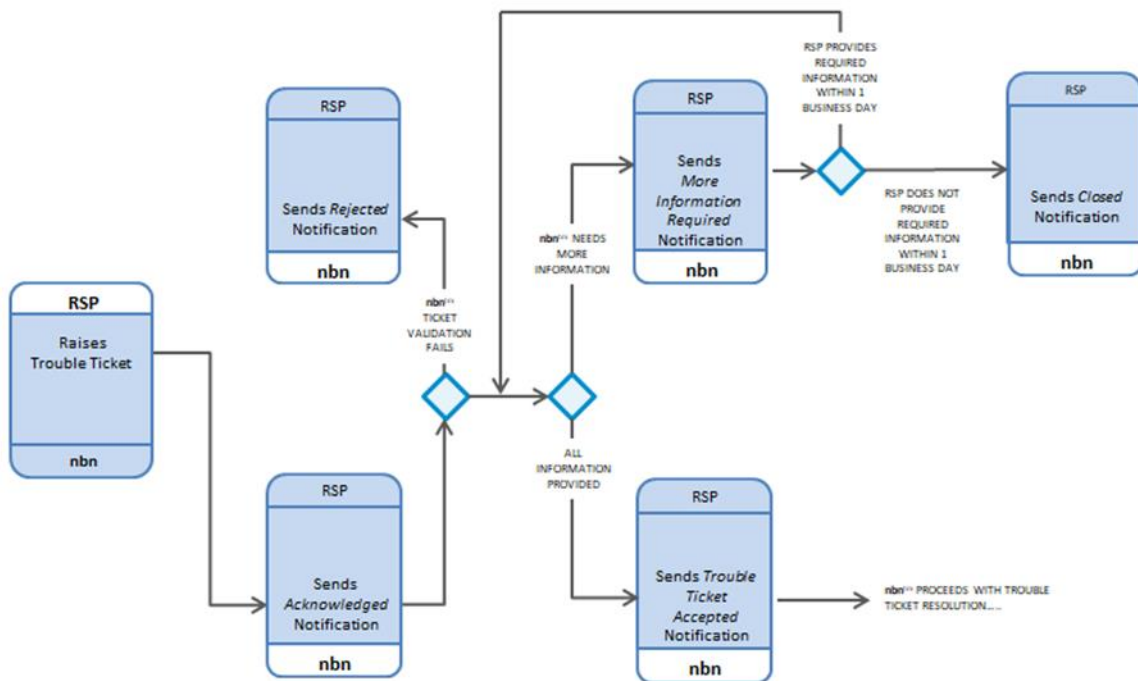

Description

The following table describes the interaction activities between **nbn** and your organisation that can arise from the raising and resolution of a Trouble Ticket.

Who	Activities
Your organisation...	<p>Uses the EE Test & Diagnostic Checklist to evaluate the fault and determines whether or not the fault is likely to be an Enterprise Ethernet Fault.</p> <ul style="list-style-type: none"> • <i>(If the results of the EE Test & Diagnostic Checklist indicate a likely Enterprise Ethernet Fault)</i> Raises a Trouble Ticket for the fault via the nbn™ Enterprise Ethernet Portal or B2B Access. • At the time of submitting the Trouble Ticket, your organisation must indicate End User Availability Time • Attaches the Test ID(s) to the Trouble Ticket. • Accurately completes the mandatory troubleshooting questions and other relevant questions for the Trouble Ticket (depending on the results of the use of test and diagnostic tools). <p>Important Notes</p> <ul style="list-style-type: none"> • Your organisation must provide all of the information specified in the Trouble Ticket in relation to the fault. nbn may use form or field validation tools to verify if all specified information is included in the Trouble Ticket. • Your organisation must select the relevant Test ID(s) prior to submitting the Trouble Ticket Note: Failure to provide the relevant Test ID(s) may result in delays to the resolution of the Trouble Ticket (refer to section 5.3.2 Trouble Tickets and the In Progress - Pending definition). • Your organisation must append any other test and/or troubleshooting results that may arise from the EE Test & Diagnostic Checklist to the Trouble Ticket. If the quantity of diagnostic information is too large to add to the Trouble Ticket, your organisation must forward it by email to the relevant RSP Support Centre contact address in the Contact Matrix and include the Trouble Ticket ID to ensure it is linked to the correct Trouble Ticket. • Your organisation must submit a Trouble Ticket in respect of each fault which it reasonably believes to be an Enterprise Ethernet Fault and must not raise more than one Trouble Ticket in respect of a fault, unless a previously resolved fault reoccurs. • If the nbn™ Enterprise Ethernet Portal or B2B Access is not available, then your organisation may raise a Trouble Ticket by telephoning the relevant RSP Support Centre contact address in the Contact Matrix. • If your organisation reports a fault using a method that is not set out above, then nbn will not act on the fault until a Trouble Ticket has been submitted correctly. • nbn may change the EE Test & Diagnostic Checklist, in which case nbn will make the updated EE Test & Diagnostic Checklist available to your organisation through the nbn™ Enterprise Ethernet Portal. nbn will give your organisation 10 Business Days' notice of any change to the EE Test & Diagnostic Checklist. • nbn may update the troubleshooting questions included in the Trouble Ticket on the nbn™ Enterprise Ethernet Portal. nbn will provide your organisation with 10 Business Days' notice of any such change. • If your organisation has ordered an NNI Link and raises a Trouble Ticket, your organisation consents to nbn disclosing the existence and details of that Trouble Ticket to the relevant Downstream V-NNI RSP. • If your organisation has ordered a V-NNI and raises a Trouble Ticket, your organisation consents to nbn disclosing the existence and details of that Trouble Ticket to the relevant Upstream NNI Link RSP.
nbn...	<p>Confirms whether or not the Trouble Ticket was submitted correctly and, depending on the result of the submission validation, does one of the following:</p> <ul style="list-style-type: none"> • <i>(If the Trouble Ticket was submitted correctly)</i> Sends your organisation an Acknowledged Notification, and updates the Trouble Ticket Status to Acknowledged. The Acknowledged Notification will include the Trouble Ticket's unique identifier (Trouble Ticket ID) • <i>(If the Trouble Ticket was not submitted correctly)</i> Sends your organisation a Rejected Notification and updates the Trouble Ticket Status to Rejected.

Who	Activities
	<ul style="list-style-type: none"> If your organisation wishes to pursue the matter further, it must raise a new Trouble Ticket. <p>Note: Trouble Tickets may receive a Rejected Notification after an Acknowledged Notification has been sent if the Trouble Ticket failed ticket validation.</p>
nbn...	<p><i>(If the Trouble Ticket was submitted correctly)</i> Evaluates the information provided in the Trouble Ticket and determines whether or not End User Availability Time has been provided and whether more information is required to proceed.</p> <ul style="list-style-type: none"> (If nbn determines that the Trouble Ticket contains all information required for the submission of a Trouble Ticket as set out in the Business Rules and End User Availability Time is specified) Sends your organisation an Accepted Notification and updates the Trouble Ticket Status to In Progress. (If nbn determines that more information and/or your organisation’s assistance is required to rectify the Enterprise Ethernet Fault) Sends your organisation a More Information Required Notification and/or a request for clarification from your organisation, and updates the Trouble Ticket Status first to In-Progress, then to In-Progress – Pending.
Your organisation...	<p><i>(If nbn sends your organisation a More Information Required Notification or requests that your organisation provide assistance to rectify the Enterprise Ethernet Fault, at any time):</i> Must, as soon as practicable and, in any event, within 1 Business Day of the date that nbn sends the More Information Required Notification or request for assistance:</p> <ul style="list-style-type: none"> gather and provide the requested information or provide the requested assistance; and update the related Trouble Ticket via the nbn[™] Enterprise Ethernet Portal and/or B2B Access.
nbn...	<p><i>(If your organisation does not provide the requested information or provide the requested assistance within 1 Business Day of receiving a More Information Required Notification or request for assistance, as applicable)</i> Changes the Trouble Ticket Status of the Trouble Ticket to Resolved and then immediately to Closed and sends your organisation a Closed Notification.</p>
nbn...	<p>Performs restoration activities to resolve the Enterprise Ethernet Fault, and depending on the outcome of those activities, does one of the following:</p> <ul style="list-style-type: none"> <i>(If the Enterprise Ethernet Fault cannot be resolved at this stage)</i> Updates the Trouble Ticket Status to In Progress and continues to investigate the Enterprise Ethernet Fault until it is resolved <i>(If the Enterprise Ethernet Fault can be and then is resolved)</i> Resolves and closes the Trouble Ticket in accordance with section 5.3.7 Resolving and Closing a Trouble Ticket.

5.3.3 External Faults

If **nbn** determines that a reported fault is an External Fault, **nbn** will update the relevant Trouble Ticket (via the **nbn**[™] Enterprise Ethernet Portal or B2B Access, as applicable) as soon as reasonably practicable, as follows:

Attendance	nbn action
<p>nbn[™] Personnel have not attended the location associated with the fault</p>	<ul style="list-style-type: none"> nbn will update the Trouble Ticket Status of the Trouble Ticket to Resolved, and send your organisation a Resolved Notification via the nbn[™] Enterprise Ethernet Portal and/or B2B Access. The Resolved Notification will provide a resolution code and a description reflecting there was no fault found and where relevant, associated comments to provide further information that may assist your organisation to understand the outcome of nbn’s Trouble Ticket investigation nbn may charge your organisation the No Fault Found (No Truck Roll Required) Charges, as specified in the nbn[™] Enterprise Ethernet Price List

Attendance	nbn action
nbn™ Personnel have attended the location associated with the fault	<ul style="list-style-type: none"> • nbn will update the Trouble Ticket Status of the Trouble Ticket to Resolved, and send your organisation a Resolved Notification via the nbn™ Enterprise Ethernet Portal and/or B2B Access. The Resolved Notification will provide a resolution code and a description reflecting there was no fault found and where relevant, associated comments to provide further information that may assist your organisation to understand the outcome of nbn's Trouble Ticket investigation. • nbn may charge your organisation the No Fault Found (Truck Roll Required) Charges, as specified in the nbn™ Enterprise Ethernet Price List

Disputing the Resolution

When a Trouble Ticket is Resolved and Closed in circumstances where **nbn** has determined that the reported fault is an External Fault, and your organisation wishes to dispute the assigned resolution code, your organisation must contact its **nbn™** Operational Point of Contact. **nbn** will then arrange a review of the Trouble Ticket resolution.

See section [5.3.7 Resolving and Closing a Trouble Ticket](#) for details of the process of closing a Resolved Trouble Ticket in other circumstances.

5.3.4 Trouble Ticket Queries

Your organisation may query the Trouble Ticket Status of a Trouble Ticket using the **nbn™** Enterprise Ethernet Portal.



Important: Your organisation must always include the Trouble Ticket ID in all communications regarding a Trouble Ticket.

5.3.5 Updating a Trouble Ticket

Each party may use the **nbn™** Enterprise Ethernet Portal or B2B Access to notify the other party of any change to an Enterprise Ethernet Fault, by adding information to the related Trouble Ticket.

If the change required to a Trouble Ticket is in relation to Trouble Ticket End User Availability Time, your organisation must follow the processes described in section [5.4.3 Amending End User Availability Time](#).

5.3.6 Technical Bridge

nbn may create a Technical Bridge as part of a Trouble Ticket investigation.



Important: A Technical Bridge is at **nbn**'s discretion. **nbn** will have regard to matters including the availability of **nbn**'s technical support resources and the severity and urgency of the circumstances relevant to the Trouble Ticket.

Who	Activities
nbn...	<p>Assesses all of the circumstances relevant to an Enterprise Ethernet Fault and may decide to create a Technical Bridge by doing the following:</p> <ul style="list-style-type: none"> • Notifies your organisation that nbn may require your organisation to attend a Technical Bridge to perform additional testing and troubleshooting for joint fault resolution • nbn's tier 2 technical support team will investigate and may engage nbn's tier 3 technical support team as required. • Updates the Trouble Ticket comments to arrange the relevant details for the Technical Bridge. If your organisation has provided contact details for its lead

Who	Activities
	technical representative, nbn will contact the representative to agree a mutually agreeable time to attend the Technical Bridge <ul style="list-style-type: none"> • Updates the Trouble Ticket based on the outcomes of the Technical Bridge.
Your organisation...	Must provide: <ul style="list-style-type: none"> • The contact details of the lead technical representative in the Trouble Ticket comments (being a member of your organisation's senior technical support teams); and • Any information and assistance requested by nbn, acting reasonably, for the purpose of the Technical Bridge.

5.3.7 Resolving and Closing a Trouble Ticket

5.3.7.1 Interactions: Closure of a Resolved Trouble Ticket

When **nbn** has resolved a Trouble Ticket **nbn** will change the Trouble Ticket Status of the relevant Trouble Ticket to **Resolved** and the Trouble Ticket will then be moved to **Closed** status in accordance with this section [5.3.7 Resolving and Closing a Trouble Ticket](#).

nbn will provide a resolution code and a description that describes how the Enterprise Ethernet Fault was resolved in the relevant Trouble Ticket, via the **nbn**TM Enterprise Ethernet Portal.



Important: If **nbn** has completed work related to a suspected Enterprise Ethernet Fault, but has determined that the fault was an External Fault, **nbn** may charge your organisation – see the [nbnTM Enterprise Ethernet Price List](#).

See section [5.3.3 External Faults](#) for additional information regarding External Faults.

Your Organisation Disagrees with a Resolution Notice

Once **nbn** has changed the Trouble Ticket Status of the relevant Trouble Ticket to **Resolved**, your organisation will have 1 Business Day to review the Resolved Notification.

If your organisation agrees with the Resolved Notification, your organisation is not required to take any further steps and **nbn** will update the Trouble Ticket Status to **Closed** once the 1 Business Day review period ends.

If your organisation disagrees with the Resolved Notification, your organisation may, within the 1 Business Day review period, leave notes in the Trouble Ticket, via the **nbn**TM Enterprise Ethernet Portal for **nbn** to review, in which case:

- *(If **nbn** agrees with your organisation that the relevant Enterprise Ethernet Fault has not been rectified)* **nbn** will update the Trouble Ticket Status to **In Progress**; and
- *(If **nbn** disagrees with your organisation)* the Trouble Ticket will remain in **Resolved** and **nbn** will update the Trouble Ticket Status to **Closed** once the 1 Business Day review period ends.

If your organisation disagrees with **nbn**'s decision to move the Trouble Ticket to **Closed**, your organisation may raise a new Trouble Ticket and escalate the Trouble Ticket to the **nbn**TM Operational Point of Contact in accordance with section [5.3.8 Escalating an Unresolved Trouble Ticket](#).

Your organisation may also raise a request for further information relating to a Closed Trouble Ticket with the **nbn**TM Operational Point of Contact.

5.3.7.2 Your Organisation Requests Closure of a Trouble Ticket

If your organisation considers that it has successfully resolved a Trouble Ticket without intervention by **nbn**, your organisation must use the **nbn**TM Enterprise Ethernet Portal to immediately notify **nbn** and request closure of the Trouble Ticket.

Activities

The following table describes the interactions between your organisation and **nbn** that can arise from your organisation requesting closure of a Trouble Ticket.

Who	Activity
Your organisation...	Identifies that the Trouble Ticket is no longer required, and requests (via the nbn TM Enterprise Ethernet Portal) that nbn close it.
nbn ...	<ul style="list-style-type: none"> Investigates, tests and/or verifies that the Enterprise Ethernet Fault has been properly resolved and does all the following: <ul style="list-style-type: none"> Changes the Trouble Ticket Status of the Trouble Ticket to Resolved and sends your organisation a Resolved Notification Changes the Trouble Ticket Status of the Trouble Ticket to Closed and sends your organisation a Closed Notification.



Important: **nbn** may impose Charges for the work, in accordance with the [nbnTM Enterprise Ethernet Price List](#).

5.3.8 Escalating an Unresolved Trouble Ticket

If your organisation wishes to escalate a Trouble Ticket where it disagrees with a Resolved Notification, it must submit a notice (**Trouble Ticket Escalation Notice**) to the **nbn**TM Operational Point of Contact

nbn will then evaluate the validity of the Trouble Ticket Escalation Notice. If valid, **nbn** will endeavour to perform work to resolve the Enterprise Ethernet Fault.

5.3.9 Enterprise Ethernet Faults related to a Network Fault

Your organisation does not need to raise a Trouble Ticket where an Enterprise Ethernet Fault is related to an identified Network Fault. However, should your organisation raise a Trouble Ticket for an Enterprise Ethernet Fault that is related to a Network Fault, **nbn** will link the relevant Enterprise Ethernet Fault's associated Trouble Ticket to the Network Fault's associated Trouble Ticket.

The Service Levels and Performance Objectives that apply to Enterprise Ethernet Faults also apply to Enterprise Ethernet Faults that have been linked in this way in accordance with section 2.2 of the [nbnTM Enterprise Ethernet Service Levels Schedule](#) and will remain the same as if the linking had not occurred. However, the rectification of the associated Network Fault may result in the Enterprise Ethernet Fault also being rectified.

5.3.10 Customer Impact Statement for Enterprise Ethernet Faults

Following an Enterprise Ethernet Fault where **nbn** and your organisation agree that it is appropriate, your organisation may request a Customer Impact Statement.

The Customer Impact Statement contains the following information:

- The timeline for the management of the event
- A description of the extent of the impact to services
- The underlying cause
- How the Enterprise Ethernet Fault was resolved
- The follow-up actions taken.

To the extent the Enterprise Ethernet Fault relates to a Type 2 Facility or other infrastructure not owned or controlled by **nbn**, the information included in the Customer Impact Statement will be limited to the information **nbn** is able to provide, based on its arrangements with the Underlying Facility Provider or other infrastructure owner.

5.3.10.1 Requesting a Customer Impact Statement

Your organisation may request a Customer Impact Statement by completing a Customer Report Request Email and emailing it to your organisation’s Operational Point of Contact as specified in the **Contact Matrix**.

Your organisation must provide the following details in the Customer Report Request Email:

- Incident number: Incident number for the event
- Criteria: Reason for request
- Contact name
- Contact phone number(s)
- Contact email address.

If the request meets the criteria set out above, **nbn** will send an acceptance notification to your organisation, prior to creating and sending the report.

If the request does not meet the criteria set out above, **nbn** will send an email to your organisation explaining why the request was rejected.

5.3.10.2 Submission period

Your organisation must submit the request for a Customer Impact Statement within 15 Business Days of the closure of the Trouble Ticket associated with the Enterprise Ethernet Fault.

5.3.10.3 Delivery of the Customer Impact Statement

If **nbn** accepts your organisation’s request, **nbn** will endeavour to provide the statement to your organisation within 15 Business Days of the date that **nbn** sends the relevant acceptance notification.

5.4 End User Availability Time

5.4.1 Introduction

Your organisation must submit all Trouble Tickets using the **nbn**™ Enterprise Ethernet Portal or B2B Access and in relation to End User Availability Time either:

- indicate 24/7 availability; or
 - provide the First Available Time,
- for **nbn** to attend the Premises to resolve the Trouble Ticket.

5.4.2 Trouble Ticket Life-cycle

5.4.2.1 Trouble Ticket lifecycle

The following table provides a high level explanation of the Trouble Ticket site visit stages and the activities which must be performed by **nbn** or your organisation in those circumstances.

Stage	Description
Site visit is organised	<p>If your organisation advises nbn of 24/7 End User Availability Time, nbn will endeavour to organise a site visit as soon as reasonably practicable.</p> <p>Note: If your organisation advises nbn of a First Available Time, nbn will endeavour to organise a site visit as soon as reasonably practicable from the First Available Time indicated.</p> <p>Where applicable, your organisation must arrange for the Appointment Representative to be present from the availability time indicated</p>

Stage	Description
Site visit in progress	nbn undertakes the necessary field work for the Trouble Ticket Note: nbn is not responsible for any RSP Equipment or End User Equipment; where reasonably practicable, nbn will reconnect RSP Equipment or End User Equipment that has been disconnected by nbn in the process of completing the necessary field work.
Site visit is complete	The site visit has concluded (including where the Appointment Representative is not in attendance at the Premises).

5.4.3 Amending End User Availability Time

Your organisation will not be allowed to amend the selected End User Availability Time.

5.4.4 Trouble Ticket site visit – **nbn** cannot access the site

The steps comprising the process where **nbn** cannot access the site and the associated activities **nbn** and your organisation must perform in relation to each step, are defined in the table below.

Who	Activity
nbn...	Where nbn cannot access the site in order to restore the service, nbn will close the Trouble Ticket.
Your organisation...	will need to lodge a new Trouble Ticket.
nbn...	may apply Charges – see the nbn™ Enterprise Ethernet Price List .

5.5 Network Fault Rectification

5.5.1 Infrastructure Restoration Trouble Tickets

When a Network Fault is identified by **nbn**, **nbn** will raise an Infrastructure Restoration Trouble Ticket for the affected retail service provider(s) (including your organisation, if applicable).

Your organisation may use the information in an Infrastructure Restoration Trouble Ticket to manage V-NNI RSP, Downstream Service Provider or Contracted End User impacts.

Upon resolution of a Network Fault, **nbn** will provide a detailed description of how the Network Fault was resolved in the Infrastructure Restoration Trouble Ticket.

5.5.1.1 Trouble Ticket Contents (submitted by **nbn**)

Infrastructure Restoration Trouble Tickets will contain all of the following information:

- The unique Trouble Ticket ID
- The services and/or Products affected by the Network Fault (by way of listing the affected OVCs).
- Description and type of the Network Fault
- Date and time at which the Network Fault is identified by **nbn**
- The geographic area affected
- The cause of the Network Fault, where known
- An estimate of the timeframe for rectification of the Network Fault, where known
- Any additional relevant information.

If **nbn** becomes aware that any of the information above is no longer current, or is otherwise inaccurate, then it will update the Infrastructure Restoration Trouble Ticket as soon as practicable.

5.5.2 nbn Reports a Fault to Your Organisation

When **nbn** identifies a fault, it will perform an initial analysis of that fault to determine whether it is an Enterprise Ethernet Fault or an External Fault. In doing so, **nbn** will then follow the following process, based on that determination.

nbn’s determination	nbn’s action
The fault is an Enterprise Ethernet Fault	If nbn suspects that the fault may have an adverse impact on your organisation’s services or Ordered Products, nbn will issue a Trouble Ticket (and associated Trouble Ticket ID) to your organisation through the nbn TM Enterprise Ethernet Portal and/or B2B Access.
The fault is an External Fault	nbn may issue a Trouble Ticket/Trouble Ticket ID to your organisation through the nbn TM Enterprise Ethernet Portal and/or B2B Access.

5.6 Planned Outages and Emergency Outages

5.6.1 Planned Outage

A Planned Outage may be carried out when **nbn** or a third party implements a change (including a change to an electricity distribution network) that may impact the services and/or Ordered Products provided by **nbn**.

5.6.1.1 Interactions: Planned Outage

The following diagram illustrates the interactions between your organisation and **nbn** that can arise from a Planned Outage.

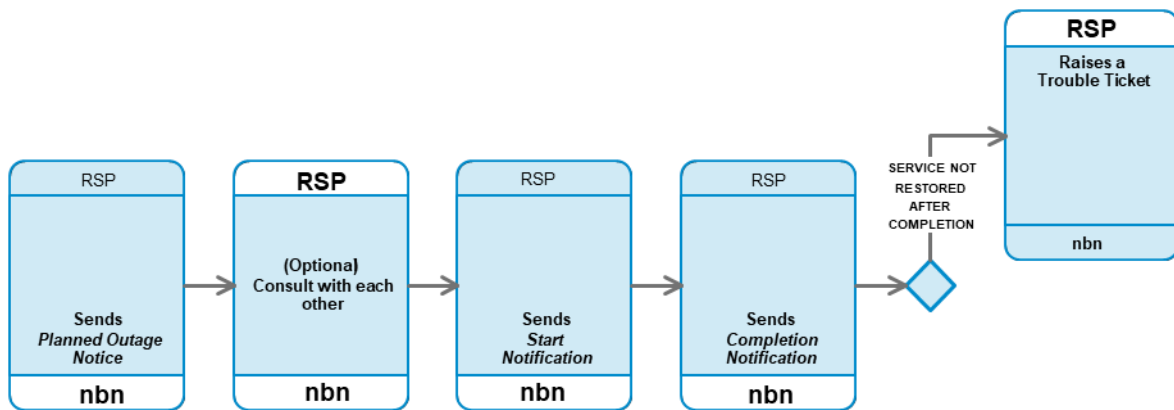

Description

The following table describes the interactions between your organisation and **nbn** that can arise from a Planned Outage.

Who	Activity
nbn ...	Sends your organisation a Planned Outage Notice.
nbn and your organisation...	Consult in accordance with clause C15.1 of the Head Terms .
nbn...	Sends your organisation a Start Notification.

Who	Activity
nbn...	(Upon completion of the Planned Outage) Sends your organisation a Completion Notification.
Your organisation...	(If the service is not restored following completion of the Planned Outage) Must raise a Trouble Ticket with nbn in relation to that issue.

5.6.1.2 Notification Channel

nbn will send Planned Outage Notices, Start Notifications and Completion Notifications to the relevant email address for your organisation as specified in the **Contact Matrix**.

5.6.1.3 Planned Outage Notice: Contents

In each Planned Outage Notice, **nbn** will include all of the following information (as applicable):

- A unique reference number
- Start and end date/time for the proposed Planned Outage
- Details and timeframes of the services and/or Ordered Products that will, or are likely to be, affected (if any); this will include, where known, the impact of the Planned Outage on your organisation (if any)
- The expected timeframe for the implementation of the Planned Outage

nbn will perform Planned Outages in accordance with the timeframes set out in the relevant Planned Outage Notice.



Important: Information provided by **nbn** regarding a Planned Outage at a Type 2 Facility will be limited to the information **nbn** is able to provide, based on its arrangements with the Underlying Facility Provider.

5.6.1.4 Planned Outage Activities: Times

Subject to clause C15 of the [Head Terms](#), **nbn** will provide your organisation with:

- At least 10 Business Days' notice of a Planned Outage;
- Where the relevant change is to perform any work including maintenance, repair, rationalisation or remediation involving any electricity distribution network to which the **nbn**TM Network is connected, as much notice as is feasible in the circumstances having regard to **nbn**'s dependence on any relevant third party.

Will nbn perform Planned Outage activities outside of these times?

Yes, including (but not limited to) any of the following circumstances:

- **nbn** needs to perform Planned Outage activities during the day (as a result of, for example, health, safety and environment issues)
- **nbn** needs to accommodate the requirements of a Third Party Supplier.

nbn will restore the services and/or Ordered Products affected by the Planned Outage within the timeframes set out in the related Planned Outage Notice.

Note: If a Planned Outage event extends beyond the notified Planned Outage period, **nbn** will treat and manage the outage as a Network Fault in accordance with section [5.5.1 Infrastructure Restoration Trouble Tickets](#).

If **nbn** becomes aware that a Planned Outage has not been restored, it will raise a Trouble Ticket.

If the Planned Outage relates to a Type 2 Facility, **nbn** may extend the notified Planned Outage period for that Planned Outage and will provide your organisation with notice of any such extension.

5.6.1.5 Planned Outage Completion

nbn will notify your organisation of the completion of a Planned Outage by sending a Completion Notification to your organisation through the **nbn**™ Enterprise Ethernet Portal and/or B2B Access.

If, on receipt of the Completion Notification, your organisation reasonably considers either or both of the following have occurred, your organisation may submit a Trouble Ticket:

- A Planned Outage has not been restored
- Your organisation's services and/or Ordered Products have been adversely affected by the Planned Outage, beyond what was originally expected or notified.

Note: Normal Trouble Ticket processes apply in dealing with a Trouble Ticket raised for this purpose.

5.6.2 Planned Outage Queries

Your organisation may view the status of the Planned Outage Notice either through the **nbn**™ Enterprise Ethernet Portal and/or B2B Access or by contacting the planned change contact (as specified in the **Contact Matrix**) via email or telephone.

5.6.3 Emergency Outages

nbn will notify your organisation of an Emergency Outage by sending a notification to your organisation through the **nbn**™ Enterprise Ethernet Portal and/or B2B Access (**Emergency Outage Notice**).

Note: **nbn** may not be able to notify your organisation before the start of an Emergency Outage.

nbn will, where feasible, endeavour to identify the following in any Emergency Outage Notice:

- The services and/or **nbn**™ Enterprise Ethernet Ordered Products used by your organisation that will be, or are likely to be, affected by the Emergency Outage
- The expected time frames for the implementation of the Emergency Outage.

Note: If your organisation becomes aware that any services and/or **nbn**™ Enterprise Ethernet Ordered Products are affected by an Emergency Outage other than as described in the Emergency Outage Notice or are not restored within the timeframe specified in the Emergency Outage Notice, your organisation may raise a Trouble Ticket, whereupon **nbn** will treat and manage the outage as a Network Fault.



Important: **nbn** may, at its discretion, not provide an Emergency Outage Notice to your organisation in respect to an Emergency Outage related to an Installation or the investigation of a Trouble Ticket. This does not affect the notifications that your organisation must provide to the relevant End User, including in respect to an Outage that affects (or is likely to affect) the End User's access to emergency services.

5.6.4 Embargo Periods

nbn may establish an Embargo Period (e.g. New Year's Day, Easter Sunday, Mothers' Day, etc.) by giving your organisation 60 Business Days notice. If **nbn** determines that an Embargo Period will be established, **nbn** will notify your organisation of the details.

Your organisation may, within 2 Business Days of being notified of an Embargo Period being established, request that the Embargo Period be deferred. If your organisation requests deferral of an Embargo Period, **nbn** will endeavour to review and respond to your organisation's request within 5 Business Days.

Your organisation may also suggest in writing that an Embargo Period be established.

If your organisation suggests an Embargo Period, **nbn** will endeavour to review the suggestion and respond, in writing, within 5 Business Days.

Module 6: Event Management

6.1 Event Management

The processes regarding Event Management in Module 7 of the *WBA Operations Manual* apply in relation to the **nbn**[™] Enterprise Ethernet Product.

Module 7: Billing and Payments

7.1 Billing and Payments

The processes regarding Billing and Payment in Module 8 of the **WBA Operations Manual** apply in relation to the **nbn**[™] Enterprise Ethernet Product, except for the following sections of the **WBA Operations Manual** which do not apply:

- section 8.4.1.4 (Billing Event File (BEF))
- section 8.5 (Claims Process for Rebates and Credits)
- section 8.6 (Credits for Satellite Test Services)

Note: Available Rebates and Credits are as detailed in the **nbn**[™] Enterprise Ethernet Product Module or as otherwise notified by **nbn** in accordance with the [nbn[™] Enterprise Ethernet Price List](#)

7.2 Invoicing

For each Billing Period, **nbn** will make each of the following forms of invoice available to your organisation (where applicable):

- Tax Invoice: in accordance with the **WBA Operations Manual**.
- Billing Invoice File (BIF): in accordance with the **WBA Operations Manual**.
- Billing Event File (BEF): in accordance with section [7.2.1 Billing Event File \(BEF\)](#)
- Billing Adjustment File (BAF): in accordance with the **WBA Operations Manual**.

7.2.1 Billing Event File (BEF)

Billing Event File (BEF)	
Description	A machine-readable file that contains an itemised list of amounts payable by your organisation for the relevant Billing Period. There are two types of Charges: <ul style="list-style-type: none"> • Recurring • Non-recurring or once off.
Format	XML
Available from	nbn [™] Service Portal or B2B Access
Frequency	Your organisation can select the BEF creation frequency at either of the following times: <ul style="list-style-type: none"> • During On-boarding: During the creation of your organisation's RSP Billing Account (<i>refer to section 2.2.1.2 in the WBA Operations Manual</i>) • Any other time: By submitting a Billing Enquiry (<i>refer to section 8.8.2 in the WBA Operations Manual</i>) If your organisation does not select the BEF creation frequency as set out above then the BEF will be created monthly, in accordance with your organisation's Billing Period.
Availability	Available for each Billing Period
Notification of availability via	Email
Contents	The items specified in clause B2.3(a) of the Head Terms , including the following:

Billing Event File (BEF)	
	<ul style="list-style-type: none"> Charges for each Ordered Product acquired by your organisation in accordance with the nbn™ Enterprise Ethernet Price List and each Discounts, Credits and Rebates Annexure Recurring Charges for core components and optional features, as they are categorised in the nbn™ Enterprise Ethernet Price List. All such charges are categorised by Product Instance ID Any non-recurring Charges in accordance with the nbn™ Enterprise Ethernet Price List and each Discounts, Credits and Rebates Annexure Rebates or Credits that are processed and applied in the current Billing Period. This may include Credits arising from settlements of Billing Disputes (see clause B5 of the Head Terms) Any pro rata adjustments applicable in accordance with clause B1.4 of the Head Terms. These include pro-rated Charges for activation, modification or disconnection of an Ordered Product. Pro-rating is based on the number of days the Ordered Product was supplied to your organisation by nbn during the applicable Billing Period.

7.3 Claims Process for Rebates and Credits

7.3.1 Credits and Rebates

Under the [WBA](#), **nbn** may provide Credits and/or Rebates to your organisation by the following methods:

Method	Action Required by Your Organisation
nbn applies the relevant Credits or Rebates (that nbn determines are applicable in accordance with the WBA) to your organisation's invoices or RSP Billing Account for the relevant Billing Period.	No action required.
nbn requires your organisation to submit a claim before nbn will provide the related Credit or Rebate to your organisation.	<ul style="list-style-type: none"> Your organisation must submit a Billing Enquiry to request a copy of the Credit/Rebate Claim Form. See section 8.8 of the WBA Operations Manual Your organisation must submit the relevant claim, using the Credit/Rebate Claim Form. See section 7.3.1.1 Submitting a Credit/Rebate claim

7.3.1.1 Submitting a Credit/Rebate claim

If your organisation wishes to lodge a Credit/Rebate claim, your organisation must ensure that its Authorised Contact completes a Credit/Rebate Claim Form and either:

- sends it to the **nbn™** Billing Contact, using the email address specified in the Contact Matrix, or
- submits it via the **nbn** RSP Support Centre

7.3.1.2 Acknowledging a Credit/Rebate claim

nbn will endeavour to acknowledge receipt of each **Credit/Rebate Claim Form** within 2 Business Days.

nbn will acknowledge a **Credit/Rebate Claim Form** by contacting your organisation's Authorised Contact or the person specified as your organisation's nominated contact person in the **Credit/Rebate Claim Form**, as applicable.

7.3.1.3 Processing a Credit/Rebate claim

nbn will only accept a **Credit/Rebate Claim Form** if it is submitted in accordance with the [WBA](#). After receiving a correctly submitted **Credit/Rebate Claim Form**, **nbn** will determine the amount of any Credit or Rebate that **nbn** will pay (if any) in accordance with the [WBA](#).

nbn will process accepted Credit/Rebate Claim Forms and provide your organisation with any applicable Credit or Rebate that **nbn** determines is payable, in one of the following ways:

- Applied to your organisation's RSP Billing Account
- In the invoice for the relevant Billing Period
- By any other means specified in the [WBA](#) for provision of that Credit or Rebate.

7.3.1.4 Rejecting Claims

nbn may reject a **Credit/Rebate Claim Form** in either of the following circumstances:

- The claim does not comply with the [WBA](#)
- **nbn** does not agree that your organisation is eligible for the Credit or Rebate which it has claimed.

What if your organisation disagrees with the amount of any Credit or Rebate applied to an invoice or with nbn's decision to reject a Credit/Rebate Claim Form?

Your organisation may raise a Billing Dispute (see clause B5 of the [Head Terms](#)).

7.3.1.5 Automatic application of Enterprise Ethernet Delivery Rebates

For each Enterprise Ethernet Delivery Rebate that is to be automatically applied by **nbn** under the [WBA](#), **nbn** will apply that Enterprise Ethernet Delivery Rebate to your organisation's RSP Billing Account within 3 months from the date your organisation becomes entitled to that Enterprise Ethernet Delivery Rebate.

Note:

Your organisation may raise a Billing Enquiry or Billing Dispute in respect of any Enterprise Ethernet Delivery Rebate it considers to be payable under this Section [7.3.1.5 Automatic application of Enterprise Ethernet Delivery Rebates](#).

Module 8: Operational Governance

8.1 Operational Governance

The processes regarding Operational Governance in Module 9 of the **WBA Operations Manual** apply in relation to the **nbn**[™] Enterprise Ethernet Product, except for section 9.3 (Operational Reporting) of the **WBA Operations Manual**, which does not apply.